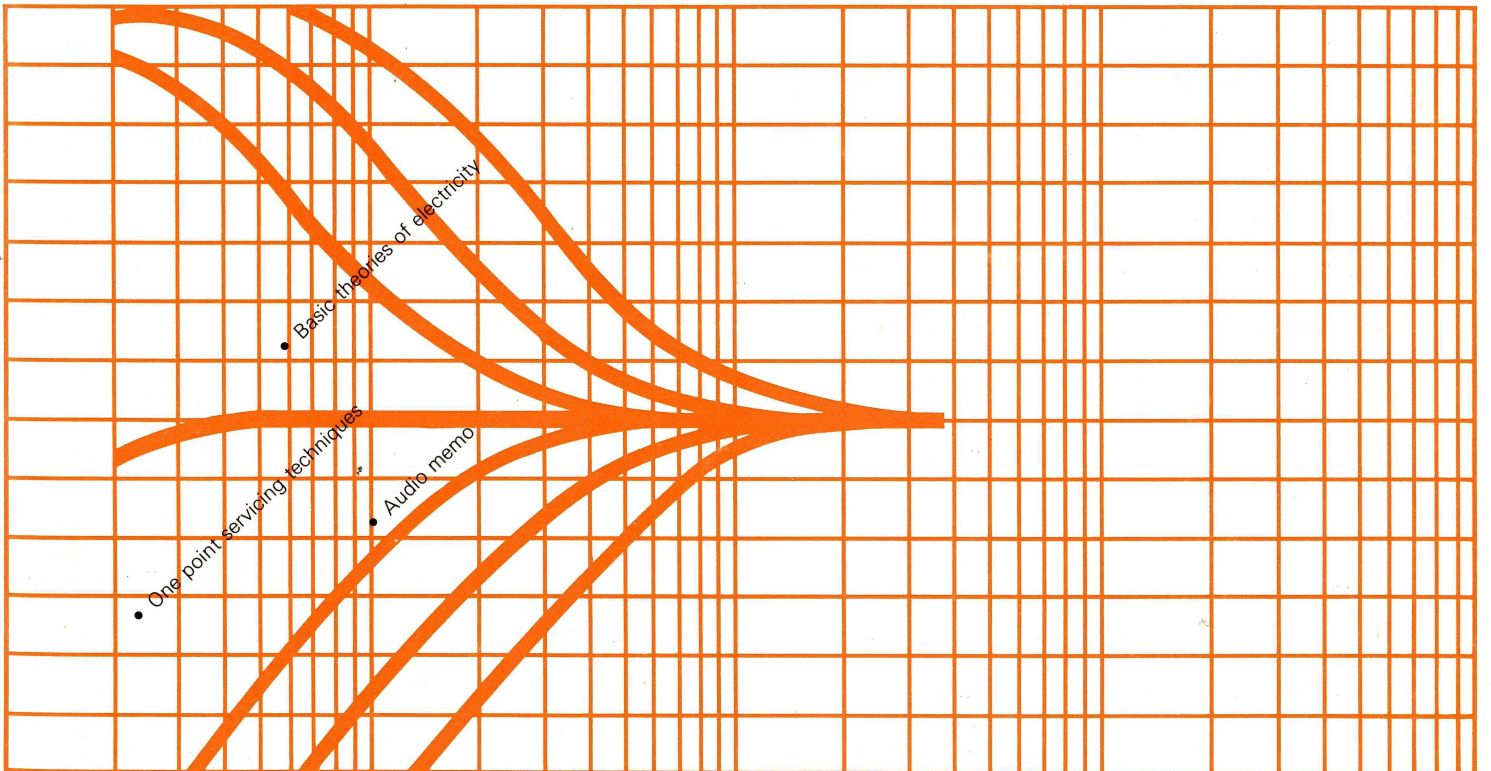


# TUNING FORK

Audio service guide

No.5



# CONTENTS

---

<b>Parts Information</b>	
<b>Diodes (1)</b> .....	<b>1</b>
<b>New Products</b>	
<b>New Direct Drive Motor</b> .....	<b>11</b>
<b>Basic Theories of Electricity</b>	
<b>Properties of Coils and Capacitors</b> .....	<b>30</b>
<b>Measuring Instrument</b>	
<b>Oscilloscopes (2)</b> .....	<b>37</b>
<b>One Point Servicing Techniques</b>	
<b>Multi-Play Deck with PMS</b> .....	<b>44</b>
<b>First Step in Audio</b>	
<b>Specifications</b> .....	<b>59</b>
<b>Audio Memo</b>	
<b>TIM Distortion/Slew Rate/Rise Time</b> .....	<b>67</b>
<b>In the Next Issue</b> .....	<b>71</b>
<b>Editor's Note</b> .....	<b>71</b>

---

# Parts Information

## Diodes (1)

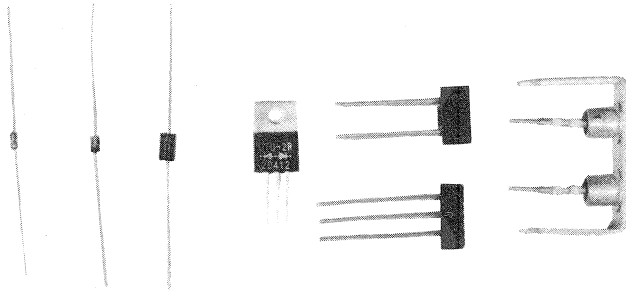
An expose of transistors was included in the last Tuning Fork issue and in this issue we take a look at diodes.

There are a gret many kinds of diodes. Many are used for detection and rectification, while some are used for constant-voltage and constant-current applications. Also included are light-emitting diodes (LED), thermistors, varistors, variable capacitance diodes and thyristors. Since it will be hard to introduce all the diodes employed by Pioneer in one issue, we shall continue in a later issue. In this issue we shall look at general detection and rectification diodes as well as regulator diodes (zener diodes).

### 1. What are diodes?

Before describing their operating principle, we shall define diodes as elements whose junction areas are made mainly of germanium, silicon or gallium arsenide (GaAs), featuring two terminals with a PN junction or one or more rectifying contacts resembling such a junction.

We shall describe diodes for rectifying applications first.



### Principle of PN junction rectification

PN junction is known as the region of transition between P-type and N-type material in a single semiconductor crystal.

When a dc potential is applied to the P-type and N-type parts of the PN junction and the P-type viewed with respect to the N-type as in Fig. 1, the positive holes in the P-type material react since the N-type material has a positive potential, and there is no flow of the holes into the N-type material. Furthermore, the free electrons in the N-type material react with the negative potential of the P-type material and they do not flow into the P-type material. As a result, there is no movement of charge between the PN areas and so hardly any current flows. In ac-

tual fact, however, a very faint saturation current  $I_s$  flows. This potential state in which an external voltage is applied to a semiconductor PN junction to reduce the flow of current across the junction is called reverse bias. When a reverse bias voltage above a certain level is supplied, a breakdown phenomenon occurs where the current increases sharply.

There are two kinds of phenomenon: zener breakdown and avalanche breakdown. (see note on page 5.)

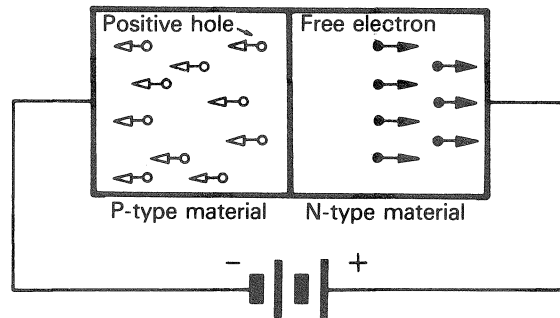


Fig. 1 Movement of free electrons and positive holes when reverse bias is applied to PN junction

If the direction in which the voltage is applied is now reversed as in Fig. 2, the positive holes in the P-type material move toward the N-type material and the free electrons in the N-type material flow toward the P-type material. Therefore, a current flows to the external circuit.

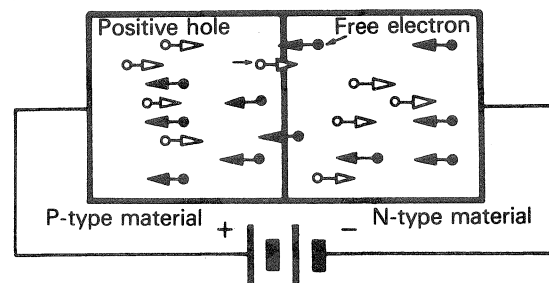


Fig. 2-a Movement of free electrons and positive holes when forward bias is applied to PN junction

A diode is, then, an element which makes use of an action where electroconductivity is shown only in one direction with respect to the directions in which the voltage of both electrodes of the PN junction is applied. Fig. 2-b gives the characteristics displayed when a forward bias voltage is applied gradually from a minus to plus region to the PN junction. This property is known as PN junction rectification. It is possible to express the forward characteristics by the following formula:

$$I = I_s \times e^{gV/KT}$$

Where g: charge  
 K: Boltzmann's constant  
 T: Absolute temperature  
 I<sub>s</sub>: Saturation current  
 V: Applied voltage

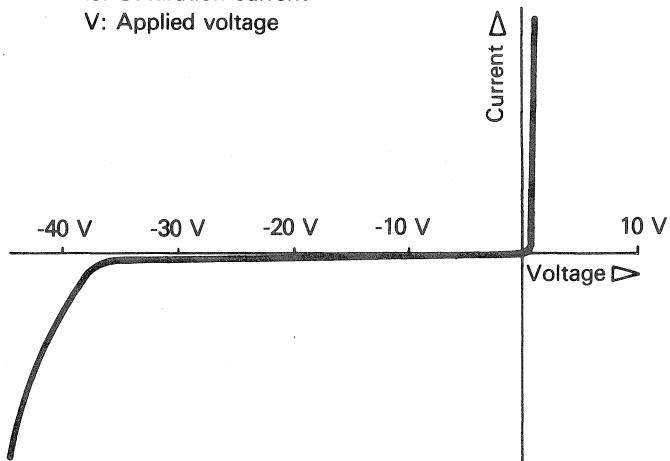


Fig. 2-b Voltage versus current characteristics of PN junction

## 2. Types of Diodes and Structures

Types of diodes as classified by structure include point contact, bonding, junction and diffused types. Also as classified by semiconductor material, germanium and silicon types exist and, using the electrical properties of the material, products are made for a number of varying applications.

### 2-1. Ordinary point contact diodes

The structure of this type of diode is shown in Fig. 3. A germanium pellet is used as one electrode and from the other is mounted an S-shaped whisker wire (probe), the whole assembly being housed in a glass or other type of insulated case with the crystal and probe touching. Typical voltage versus current characteristics are shown in Fig. 5.

The current is prone to flow in the direction of the pellet side from the electrode where the probe is mounted and not in the direction of the probe from the pellet side. The former direction is characterized by forward characteristics and the latter direction by reverse characteristics. Each direction is connected continuously at the zero bias point.

The forward characteristics of the diode are indicated by the drop voltage  $V_f$  at the rated current or by the current when the rated voltage is applied. The reverse characteristics are expressed by the breakdown voltage or puncture voltage  $V_r$  at which the resistance of the diode falls sharply and the leakage resistance  $R_b$  or leakage current  $I_b$  at rated voltage is applied.

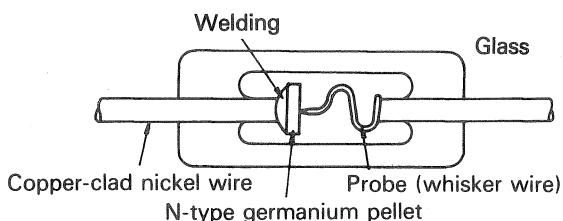


Fig. 3 Construction of point contact diode

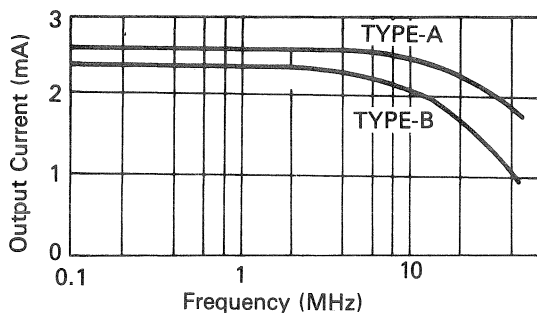


Fig. 4 Frequency response of germanium diode

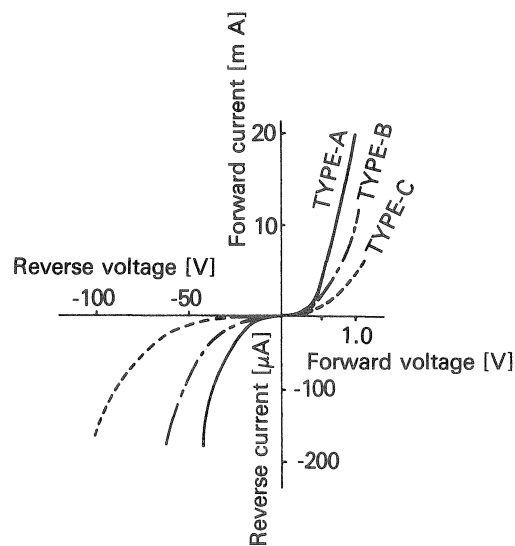


Fig. 5 Voltage versus current characteristics of point contact diode

It is not possible to obtain good rectification characteristics with a point contact structure using a P-type germanium crystal but excellent nonlinear characteristics can be provided with an N-type crystal alone.

The probe can be formed in the shape of the letter "S" or "C" with a diameter of about 0.05 to 0.15 mm and a sharp tip. Main materials are tungsten, a tungsten alloy or platinum alloy. There is hardly any difference in the electrical characteristics with the probe material. Fig. 4 shows the frequency response of a germanium diode, and it can be seen that there is a sharp drop from about 10 MHz or more. This happens because the electric field is inverted before the positive holes injected disappear in the crystal with the result that the reverse resistance drops due to the conductivity of the holes. This phenomenon is known as the hole storage effect.

Germanium diodes which are manufactured nowadays are given forming treatment during their production. This consists in allowing a pulse current of about 0.5 A to flow from the forward or reverse direction to the diode device for between one and several times during a short time duration, and by so doing a small area near the N-type germanium point contact is changed into a stable P-type area where the actual PN junction is formed. By varying the conditions during this treatment, the characteristics can be freely controlled.

Since their structure is simple and costs are low, these diodes are used in detection, meter rectification, modulation, mixing and limiter application.

## 2-2. Junction diodes for detector (alloy type, diffused type)

In germanium diodes with this structure the N-type germanium pellet is joined by indium or an indium alloy, or by a small lump of gallium or other alloy containing P-type impurities, and an alloy formed in a reductive atmosphere. This type of diode goes into limiters, amplitude compressors, harmonics generators, ring modulators and varistor diodes for temperature compensation of transistors. Hardly any diffused germanium diodes are manufactured.

On the other hand, both alloy and diffused types of silicon diodes are practically applied. Fig. 6 gives an example of the construction. These miniature diodes have a glass seal and many have a thicker metal electrode at the base side in order to improve the heat radiation and increase the current capacity.

Alloy silicon diodes normally use an ordinary N-type crystal, a pure aluminum wire or disc is alloyed to the PN junction at a temperature from 600°C to 700°C, and for the ohmic connection, an Au-Sb (gold/antimony) alloy is fused with the base electrode at 400°C to 500°C. The other electrode is made into the shape of an "S" with a spring leaf welded or pressure bonded onto the head of the alloy.

In the alloy type the size of the junction tends to fluctuate and, due to this, diodes are separated into those for ordinary applications and variable capacitance diodes and zener diodes.

There are two types of structure with the diffused type of diode: mesa and planar. Fig. 7 gives an outline of the production stages. The diffused types are rather more complex than the alloy type but because the characteristics are easy to adjust and uniform, they are suited to mass production.

This type is used for general applications and also for zener diodes, high-Q variable capacitors and others. More recently, they are being employed for digital circuit switching in electronic switching systems and computers.

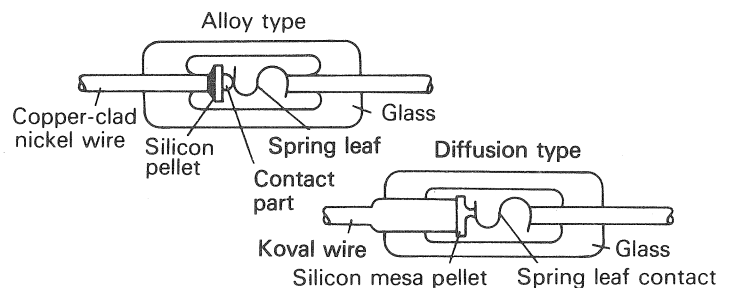


Fig. 6 Construction of silicon diode

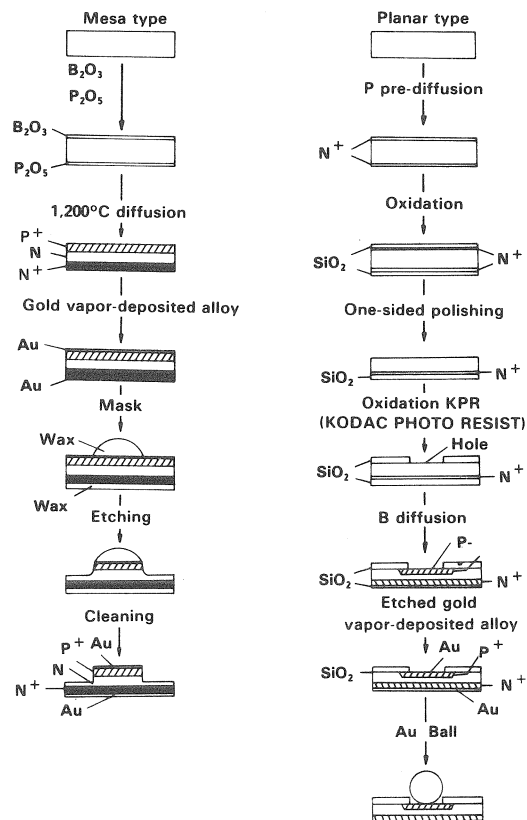


Fig. 7 Production stages of diffused type diodes

### 2-3. Diodes for Rectification

Fig. 8 is a comparison of the rectification efficiency of various rectifiers. Compared with others, germanium and silicon rectifiers have a much better efficiency, and in the case of rectifiers having the same capabilities, the germanium and silicon diodes have a much smaller size even including the heat sink. This is due to the high current density of the germanium and silicon junction, amounting to 100 A/cm<sup>2</sup>. It is also possible to produce elements with a high reverse dielectric strength, and some with a value of more than 1000 V are manufactured.

As can be seen from the graph in Fig. 8, germanium and silicon diodes have excellent characteristics at a low voltage. This is because, compared with other elements, the rise in the forward current is excellent. The forward voltage drop is about 0.5 V at normal temperature with germanium diodes and about 1.1 V with silicon diodes. Germanium diodes are suited to applications involving a high output current and a comparatively low voltage. Silicon diodes are suited to general applications where they are used in high voltages and high ambient temperatures.

Both alloy and diffused types are available as rectification diodes. Heat expansion, however, interferes with the performance of alloy types and so almost all the diodes are diffused types. Fig. 9 shows the construction of a diffused type. This is a pin construction where the intrinsic semi-conductor area is sandwiched in the center. The P-type impurities are diffused from the high-resistivity silicon wafer side while the N-type impurities are diffused from the other side to form a PN junction. This PIN structure has an extremely high reverse dielectric strength and the forward characteristics are such that the voltage drop can be reduced by reducing the resistance by injecting a small number of carriers into the intrinsic region, and it is possible to obtain superlative characteristics as a rectification diode.

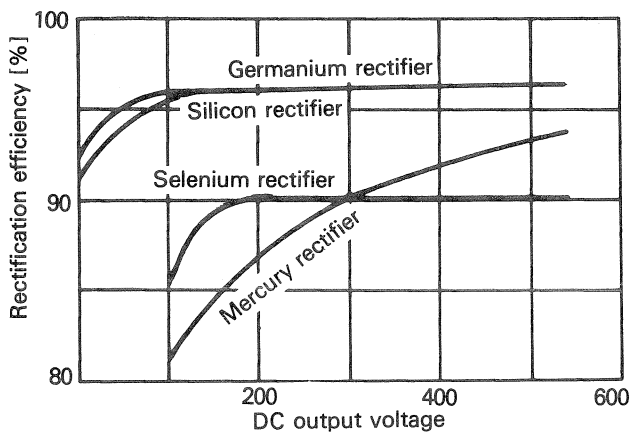


Fig. 8 Rectification efficiency of rectification semiconductors

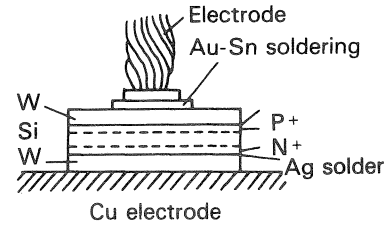


Fig. 9 Structure of diffused type diode

### 2-4. Zener diodes (regulator diodes)

With this type of diode, the current is extremely low and with the level above it the current increases sharply at that voltage. This is called breakdown effect. The two reasons for the above phenomenon are avalanche and zener effect.

There are two reasons for the above phenomenon. In the silicon diode, the breakdown voltage up to 6 V is considered to be caused by zener effect and at 6 V or more by avalanche.

Silicon only is used for zener diodes because of its properties: a great current variation at the avalanche region, a small reverse saturation current and it can be used at high temperatures.

The construction of these diodes is the same as that of junction diodes produced by the alloy or diffusion method. Nowadays only the diffused type is used and by varying the conditions of diffusion, diodes with various breakdown voltages across an extremely wide voltage range are manufactured. Like other semiconductor products, zener diodes have temperature characteristics.

Fig. 10 shows the temperature dependency of the breakdown voltage of zener diodes. According to this figure, the temperature coefficient approaches zero near 6 V, with diodes having a plus coefficient at a higher voltage and with diodes having a minus coefficient at a lower breakdown voltage. In other words, the breakdown voltage caused by electron avalanche increases when the temperature rises, and internal electron emission due to the zener effect decreases when the temperature rises.

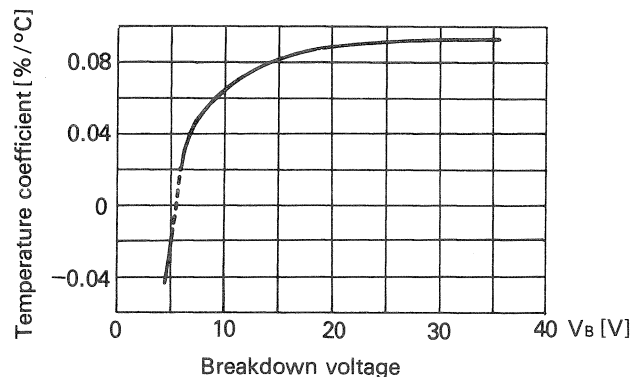


Fig. 10 Breakdown voltage of temperature dependency

**Note 1) Electron avalanche**

The carriers are released by the electric field and so if they crash into the crystal frames, for instance, and do not lose speed, they take on motion energy. If this energy is greater than the ionized energy, the carriers isolate the electrons which form the crystal, new electron-hole pairs are formed, and these in turn become carriers again. Therefore, if the electric field applied is great, electron hole pairs are formed successively and the electroconductivity increases sharply. This phenomenon resembles an avalanche and so this is called electron avalanche.

When a reverse voltage is applied to the PN junction and the voltage is gradually increased, the carriers formed near the junction by the heat energy and the carriers formed by the zener effect through the electrical field trigger a rise in the carriers caused by electron avalanche and this results in a breakdown. This is known as electron avalanche breakdown.

**Note 2) Zener effect**

When a strong electric field is applied to a crystal, the electrons of the atoms making up the crystal — or the electrons which were restrained in a weak electrical field — become carriers due to the electrical field, and the creation of electroconductivity is known as the zener effect.

**2-5. Rectifying diode specifications**

Ratings are prescribed for the following items in the diode specifications. Given below is an example.

	GP-25B	GP-25D	GP-25G
1) Peak reverse voltage	100	200	400
2) Recommended ac input voltage	70	140	280
3) Maximum dc output current	2.5 A (at 75°C), 9.5 mm lead length		
4) Surge current	100 A		
5) Usable ambient temperature	-65 ~ +150°C		
6) Forward voltage drop	MA × 1.1 V (at IF = 2.5 A)		
7) Reverse current (PPV)	MA × 5.0 A (at Ta = 25°C) MA × 100 A (at Ta = 100°C)		

(Ta = 25°C)

**Fig. 11 Allowable output current and temperature**

**1) Peak reverse voltage**

With either of the rectification systems this is equivalent to 2 times the secondary voltage (2√2 times with the center tap system), and so this value must be guaranteed when designing a rectifier circuit.

**2) Recommended ac input voltage**

This is the voltage recommended for safety purposes given the fact that the voltage sometimes reaches a value several times its ordinary value in cases where a sudden burst of transient voltage is generated by the on/off operation of a power supply circuit switch, for instance.

**3) Maximum dc output current**

This is the value with half-wave rectification. With full-wave rectification, it is distributed over each of the half cycles and so it can be used as double the capacity with load currents. This dc output current is restricted by the following:

- As shown in Fig. 12, the dc output current is restricted by the ambient temperature, and when the temperature rises, the allowable output current drops.
- Normally diodes are mounted on printed circuit boards for use. In this case, their leads are cut but if the leads are cut too short, the allowable current will drop. This is because the leads themselves serve as a kind of heat sink. (In actual fact, this does not pose much of a problem as there are effects from the shape of the pcb pattern and others.)

**4) Surge current**

Fig. 13 gives the relationship between the GP-25's guaranteed surge value and the number of energizing cycles. It can be seen that the guarantee applies even with quite a high momentary current.

Surge is the secondary maximum voltage divided by the total resistance of the circuit and so it is equivalent to:

$$\sqrt{2} Es/Rt$$

where Es is the secondary voltage

Rt is the load resistance + internal resistance of diode

When the capacity of a smoothing circuit is high, Rt is almost always determined by the dc resistance of the secondary winding. Surge results mainly when the power switch is set to ON and it reaches its maximum value at the peak of the waveform at the ON position.

Fig. 14 shows a full-wave rectifier circuit with a capacitor and surge flows in relation to the ac peak value to the capacitor. In the circuit shown in Fig. 14 the state of surges i<sub>1</sub> and i<sub>2</sub> flowing through the capacitor when the switch is set to ON is shown in Fig. 15. When the first surge flows with D<sub>1</sub> energized, the maximum value is i<sub>im</sub>, and when D<sub>2</sub> is energized, it is reduced since the capacitor is charged. After this has been repeated several times, a ripple current is produced.

In actual fact, there is very little likelihood that surge will result with a commercial ac power line (mains) peak but just in case, Pioneer's high power output amplifiers are provided with a surge killer circuit for safety.

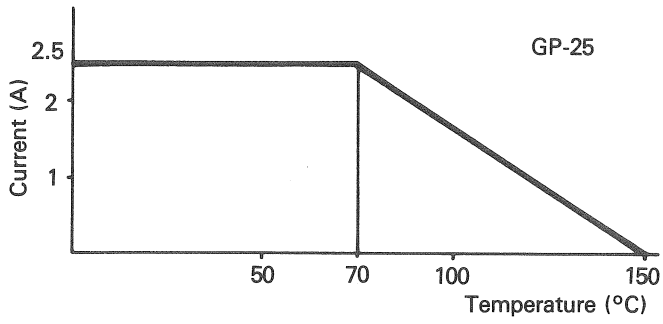


Fig. 12 Allowable output current and temperature

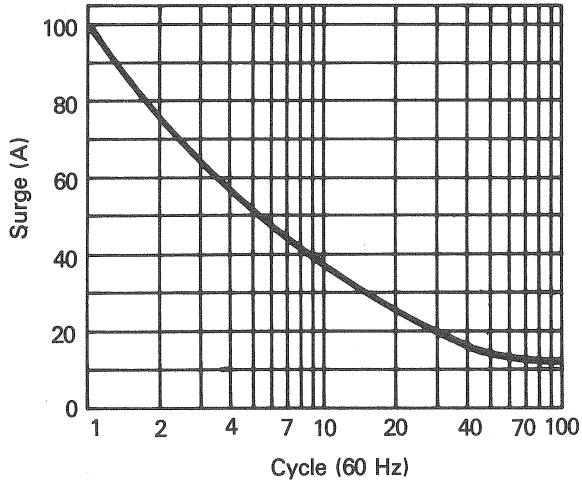


Fig. 13 Guaranteed surge value and energizing cycle

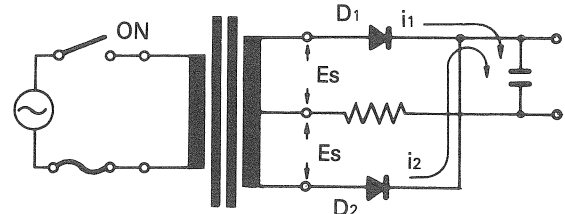


Fig. 14 Full-wave rectifier circuit and surge current

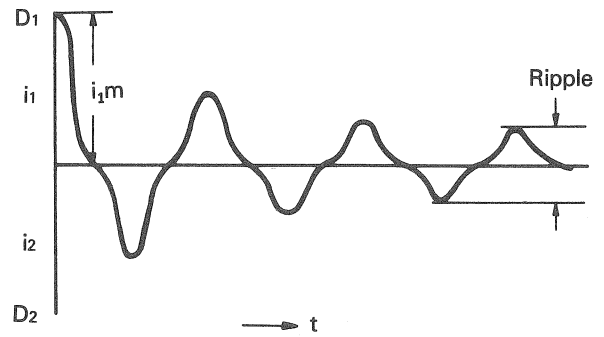
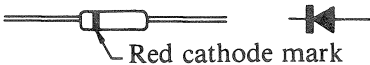
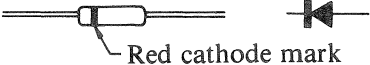
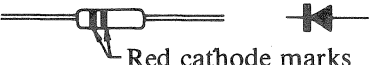


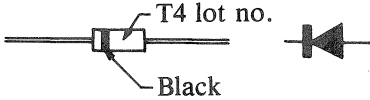
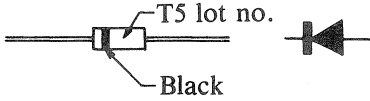
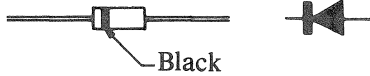

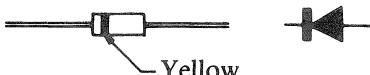
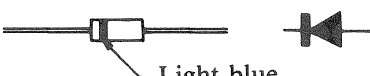
Fig. 15 Surge in full-wave rectifier circuit



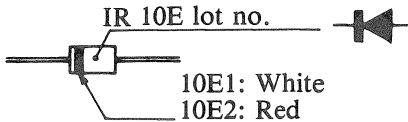
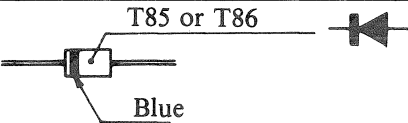
**For detection applications**

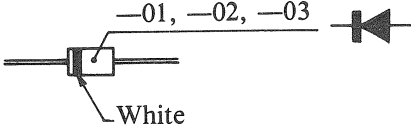
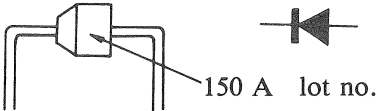
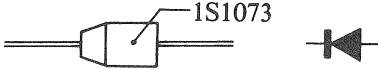
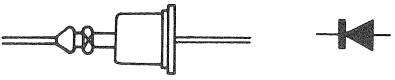
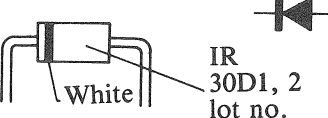
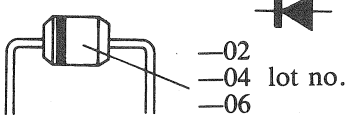
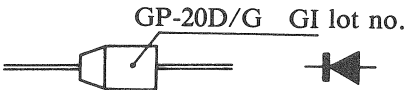
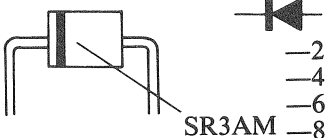
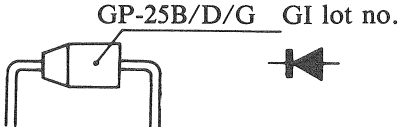

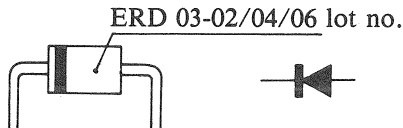
Parts No.	Manufacturer	I (A)	VR (V)	Construction	Exterior, marking, internal connection	Remarks
1N60	Hitachi	0.05	25	Point contact germanium	 Red cathode mark	
1S188FM-1	Sanyo Unison	0.05	35	Point contact germanium	 Red cathode mark	
1S188MPX	Sanyo	0.05	35	Point contact germanium	 Red cathode marks	

**For general detection and rectification**

Parts No.	Manufacturer	I (A)	VR (V)	Construction	Exterior, marking, internal connection	Remarks
1S1554	Toshiba	0.1	50	Epitaxial planar type	 T4 lot no. Black	
1S1555	Toshiba	0.1	35	Epitaxial planar type	 T5 lot no. Black	
1S2471	Toyo Dengu	0.11	100	Epitaxial planar type	 Black	
1S2472	Toyo Dengu	0.12	50	Epitaxial planar type	 Green	
1S2473	Toyo Dengu	0.11	35	Epitaxial planar type	 Yellow	
1S2076	Hitachi	0.1	30	Epitaxial planar type	 Light blue	

**For power rectification**

Parts No.	Manufacturer	I (A)	VR (V)	Construction	Exterior, marking, internal connection	Remarks
10E1 10E2	IR	1.0	100 200	Diffused junction type	 IR 10E lot no. 10E1: White 10E2: Red	
1S1885 1S1886	Toshiba	1.0	100 200	Diffused junction type	 T85 or T86 Blue	

Parts No.	Manufacturer	I (A)	VR (V)	Construction	Exterior, marking, internal connection	Remarks
SIB01-01 SIB01-02 SIB01-04	Fujidenki	1.0	100 200 400	Diffused junction type		
DS-150A	Sanyo	1.5	200	Diffused junction type		
1S1073	Origin	1.5	400	Diffused junction type		
DS-118A	Sanyo	1.5	200	Diffused junction type		
30D1 30D2	IR	1.7	100 200	Diffused junction type		
ERC01-02 ERC01-04 ERC01-06	Fuji	1.8	200 400 600	Diffused junction type		
GP-20D GP-20G	GI	2.0	200 400	Diffused junction type		
SR3AM-2 SR3AM-4 SR3AM-6 SR3AM-8	Mitsubishi	2.1	100 200 300 400	Diffused junction type		
GP-25B GP-25D GP-25G	GI	2.5	100 200 400	Diffused junction type		
HS-3	GI	3.0	400	Diffused junction type		
ERD03-02 ERD03-04 ERD03-06	Fuji	3.0	200 400 600	Diffused junction type		

Parts No.	Manufacturer	I (A)	VR (V)	Construction	Exterior, marking, internal connection	Remarks
IS1850 IS1860R	Sanken	1.5	200	Diffused junction type		
SIB02-01C SIB02-03C SIB02-06C	Fuji	1.5	100 300 600	Diffused junction type		
SB3-02P SB3-04P SB3-06P	Origin	2.0	200 400 600	Diffused junction type		
SS-3 SS-3R SS-5	Sanken	3.5	200 200 200	Diffused mesa type		
S5151 S5151R	Toshiba	5.0	200 200			
KBH25-02 KBH25-04	GI	25	200 400			

Parts No.	Manufacturer	I (A)	VR (V)	Construction	Exterior, marking, internal connection	Remarks
SG-5TS	Sanken	6.0	300			
SG-5TR			300			

**For voltage regulation**

Parts No.	Manufacturer	Regulator Voltage		Construction	Exterior, marking, internal connection	Remarks
		min [V]	max [V]			
BZ-120 BZ-130 BZ-320 BZ-340	JRC	11.4 12.4 30.6 32.6	12.6 13.6 33.4 35.4	Diffused junction type	 (Example) B120 Black cathode	
MZ322-A	Mitsubishi	20.9	23.1	Epitaxial planar type	 Z22A Black cathode	
EQA01-05SA EQA01-33R EQA01-35R	Fuji	4.9 31.8 33.8	5.1 35.2 37.3	Epitaxial planar type	 35 lot no. White cathode	
XZ-060 WZ-061 WZ-081 WZ-100 WZ-110 WZ-120 WZ-130 WZ-140 WZ-150 WZ-157 WZ-177 WZ-192 WZ-197 WZ-210 WZ-220 WZ-240 WZ-250 WZ-320	JRC	5.8 5.7 7.7 9.5 10.4 11.4 12.4 13.4 14.4 14.9 16.9 18.4 18.9 19.8 20.8 22.8 23.8 30.6	6.2 6.5 8.5 10.5 11.6 12.6 13.6 14.6 15.6 16.6 18.6 20.1 20.6 22.2 23.2 25.2 26.2 33.4	Diffused junction type	 W061 Black cathode	
MZ205-26A	Mitsubishi	4.4	5.6	Epitaxial planar type	 MZ5 Black cathode	
HZ7-B	Hitachi	6.9	7.5	Epitaxial planar type	 7B Blue Blue cathode	

# New Products

## New Direct Drive Motor

### 1. Introduction

It is now about ten years since direct drive (DD) motors were first used in turntables.

At the outset, only the top-of-the-line turntables featured these motors but nowadays they have become commonplace. They are also being adopted as capstan motors in tape decks. The reasons for the spread of the DD motor are to be found originally in the demand for enhanced performance as it refers to the rotational performance and more specifically wow/flutter of rotary-driven equipment and in advances made in recent IC techniques. These made it possible to configure complex servo circuits with relatively few parts and as a result it became possible to cut production costs.

Recent technological trends in DD motors are now described.

The precision of mechanical parts is naturally being upgraded, and in particular, great improvements have been recorded in the rotational performance through enhancing the precision of the shaft and bearings.

Pioneer, however, has revolutionized the structure of the motor in order to enhance its rotational performance.

Fig. 1 shows the stable hanging rotor (SHR) motor, a motor with a new structure.

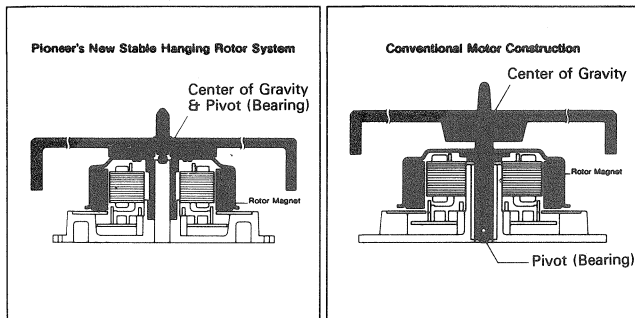


Fig. 1 Construction of conventional motor and SHR motor

As can be seen in the figure, the center of gravity and the fulcrum of the SHR motor virtually coincide. By eradicating all instability in the platter (reverse conical movement and rotational slip, etc. caused by the lubricating oil used between the shaft and bearings), the original characteristics before servo engagement are improved and the rotational performance is enhanced.

Another recent trend in turntables is their increasing dimensional thinness.

Naturally, a slim-line turntable requires an equally slim-profile motor.

To meet this requirements, a slot-less motor is adopted for reduced thickness (see Photo 1).

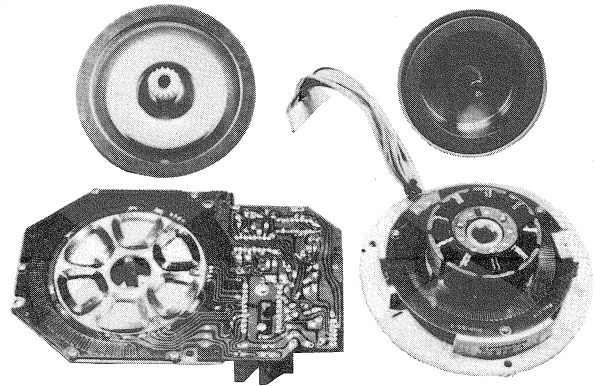


Photo 1. Slotless motor and slot motor

The servo circuit has come to fully adopt ICs thanks to the progress made in IC technology.

Through the use of ICs, the number of parts in the complex servo circuit is reduced and it has been possible to produce low-cost DD motors. This is the reason why DD motors are now incorporated in mass-market turntables.

At the same time, the performance of the IC themselves has been improved. Their temperature and humidity resistance as well as their other characteristics have greatly been improved over the performance of discrete circuits using transistors.

Technological advances and innovation have in some cases made the performance of recent DD motors impossible to measure with currently available measuring methods — or, at least, the values now being recorded are below the measurable limits. However, the introduction of ICs has made it more difficult to understand the operation of the servo circuit. An explanation is given in the Service Manual but in the following pages the basic operations of the servo circuits used by Pioneer will be reviewed and the operations of some integrated servo systems will be described in detail.

## 2. Types and Features of Servo Systems

It is well-known that Pioneer uses three kinds of servo systems in its DD motors.

The principles behind the basic operations of these three servo systems and their features, together with the performance ranking of each system and a table of Pioneer models employing the systems, now follow.

### 2-1. E-servo system

#### (a) Principle of basic operation

In this system the motor-driving coil is used as the speed detector.

Only one phase, or part of the 3-phase coil is required to generate the torque at a time which means that no current flows in the two other parts letting them rest and wait

their turn. However, actually, an electromotive force (proportionate to the rotational speed) is generated in accordance with Fleming's right-hand rule (principle of a generator) in this 2-phase coil. This force is used to detect the rotational speed.

The electromotive force generated in the drive coil is rectified to get a dc voltage which is proportionate to the rotational speed.

This dc voltage is compared with the reference voltage supplied from the reference voltage generator by the voltage comparator. The rotational speed is kept constant by the drive current which is controlled by the difference between the two voltages.

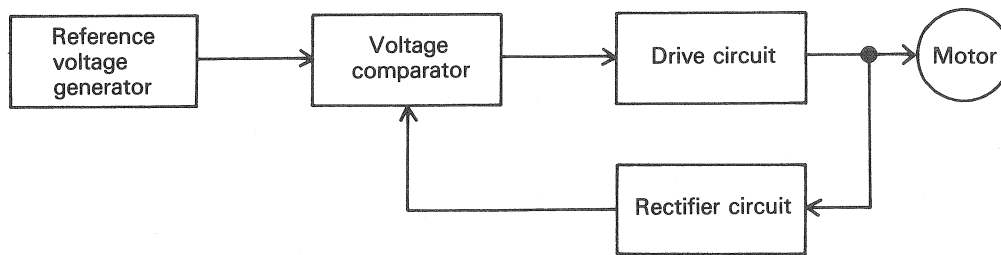


Fig. 2 Block diagram of E-servo system

#### (b) Features

Since the drive coil is used as the speed detector, there is no need for a separate speed detector, and because of the simple system for getting the dc by rectifying the generated current, it is possible to reduce the number of parts used and cut down the manufacturing costs.

In this system, however, more parts affect the performance (wow/flutter, temperature drift, etc.) than in other systems.

Some of the problems involved are:

- Inequality of resistance and inductance between the three pieces of the drive coil.
- Tolerance of rectifying diode in  $\Delta V_F$  (slightly varying forward voltage)
- Uneven magnetism of magnets
- Temperature characteristics of all parts

Measures taken to counter these factors include the selection of parts, improvement of the parts in precision and use of temperature compensating circuits.

## 2-2. F-servo system

### (a) Principle of basic operation

This system is characterized by a built-in speed detector known as a frequency generator whose magnet turns with that of the motor and generates a frequency in proportion to its speed.

A signal is generated by the frequency generator (FG) in proportion to the rotational speed of the motor.

The frequency of this signal is converted into a voltage by the frequency/voltage (F-V) converter and this is compared with the reference voltage by the comparator. The difference between the two voltages is supplied to the drive circuit, controls the drive current, and keeps the rotational speed constant.

### (b) Features

Since a frequency generator is used in this system for the speed detector, the cost of the parts is naturally higher than that for the E-servo system.

However, since the rotational speed of the motor is detected with a frequency and the circuit is designed so that this frequency is controlled, errors in the part which is most sensitive to speed control are reduced to the minimum and thus, the performance is improved.

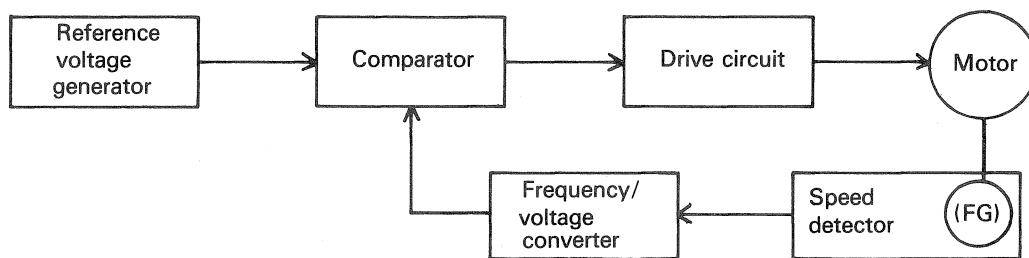


Fig. 3 Block diagram of F-servo system

## 2-3. Quartz-PLL servo system

### (a) Principle of basic operation

Like the F-servo system, this system features a built-in frequency generator as the speed detector. But unlike the F-system, it employs a quartz oscillator as the reference signal generator.

As with the F-servo system, the speed detection employs a frequency generator whose signal (frequency) is supplied to the comparator.

However, unlike the F-system, a signal is supplied from the quartz oscillator as the reference signal.

The quartz oscillator signal is compared with the FG signal generated in line with the motor's rotational speed,

the difference is sent to the drive circuit and controls the drive current, thus the rotational speed is maintained at a constant level.

### (b) Features

Since this system adopts an extremely accurate quartz oscillator as the reference signal generator, it may be described as the best servo system for creating a DD motor with a high performance and high reliability. However, the use of a high-priced quartz oscillator and a frequency divider IC makes the cost of the unit high.

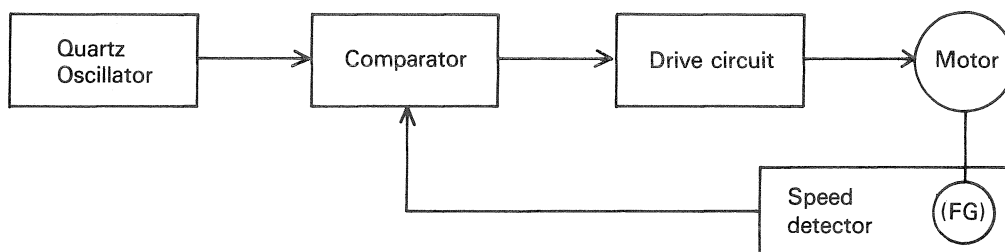


Fig. 4 Block diagram of Quartz-PLL servo system

## 2-4. Ranking of servo systems by performance applicable models

The ranking given here is based on the principle of the systems' operation only. This is because it is difficult to make comparisons using presently available measuring methods (JIS, DIN, etc.) since some items cannot be measured at all and others border on the measurable

limits and circuit technology and IC techniques are advancing all the time. This means that in many cases the performance is on the same level. (Actually, wow/flutter has to be measured with a special method; otherwise it is not possible to see any difference.)

So, the table below is only a reference.

System/Item	Wow/flutter	S/N	Load characteristics	Drift	Applicable models
E servo	3	1	3	3	PL-3000, PL-455
F servo	2	1	2	2	PL-200, PL-250, PL-255 PL-260
Quartz PLL	1	1	1	1	PL-300, PL-400, PL-500 PL-600, PL-L1000, CF-F1250

**Table 1 Ranking of servo systems by performance and applicable models**

## 3. Servo System Operation

The control and drive circuits of the Pioneer DD motors are all integrated.

The ICs classified by servo system are given below:

- E-servo: PA3006
- F-servo: PA2004, PA2005
- Quartz PLL: PD1003, PA2004, PA2005

In order to understand the principle behind the DD motor's operation, it is first necessary to understand the functions of the IC used.

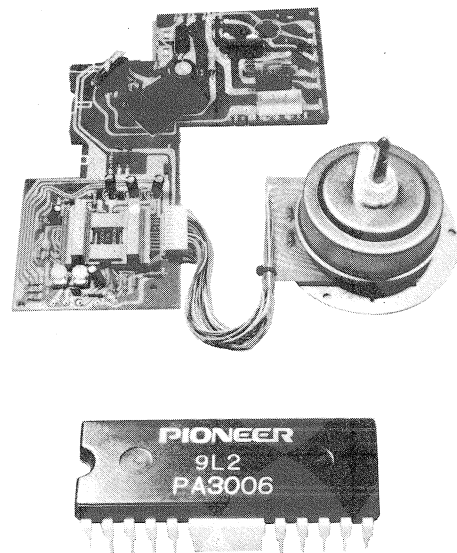
The functions of the ICs are described in the Service Manuals of each turntable. However, for further understanding, the principle behind the operation of the servo circuits (centering on the IC) is described here. The block diagrams used here differ slightly from those found in the Service Manuals apart from the actual application for easy understanding since the ICs have multiple functions for versatility.

Descriptions of the drive circuit, position detector circuit, drive current control circuits in the drive system have been omitted since details can be found in the Service Manuals. Reference should therefore be made to the respective Service Manual.

### 3-1. E-servo DD motor operation

The IC used in this circuit is PA3006.

PL-3000 and PL-455 turntables adopt this system. Fig. 5 is a block diagram while the motor unit and IC are shown in Photo 2.



**Photo 2 Motor unit and IC**



In the E-servo system, the speed detection voltage, which is produced by rectifying the counter-electromotive current generated in the drive coil while the motor rotates, naturally contains ripple.

When the speed detection voltage which contains ripples is compared with the reference voltage, the ripple gets the control voltage of the rotational speed and increases wow/flutter.

This is why a low-pass filter (LPF) must be installed to eliminate the ripple. The lower the cut-off frequency, the smaller ripple and wow/flutter is reduced.

However, lowering the cut-off frequency increases the time constant of the LPF on the other hand, and, in other words, a long time constant on the speed control loop makes the transfer function (response speed) slow.

In this way, the wow/flutter and response characteristics are reciprocal. In order to obtain a balance in this relationship, the optimum cut-off frequency of the LPF must be found.

Let's take a closer look at the response characteristics.

If the response time is long, it takes long to get stable platter rotation after starting or sudden load variation.

Another thing which must be done is to reduce the wow/flutter when the platter is rotating at a constant speed.

Taking these points into consideration, the PA3006 has circuits for improving the response characteristics and wow/flutter.

Now, let's go into each block.

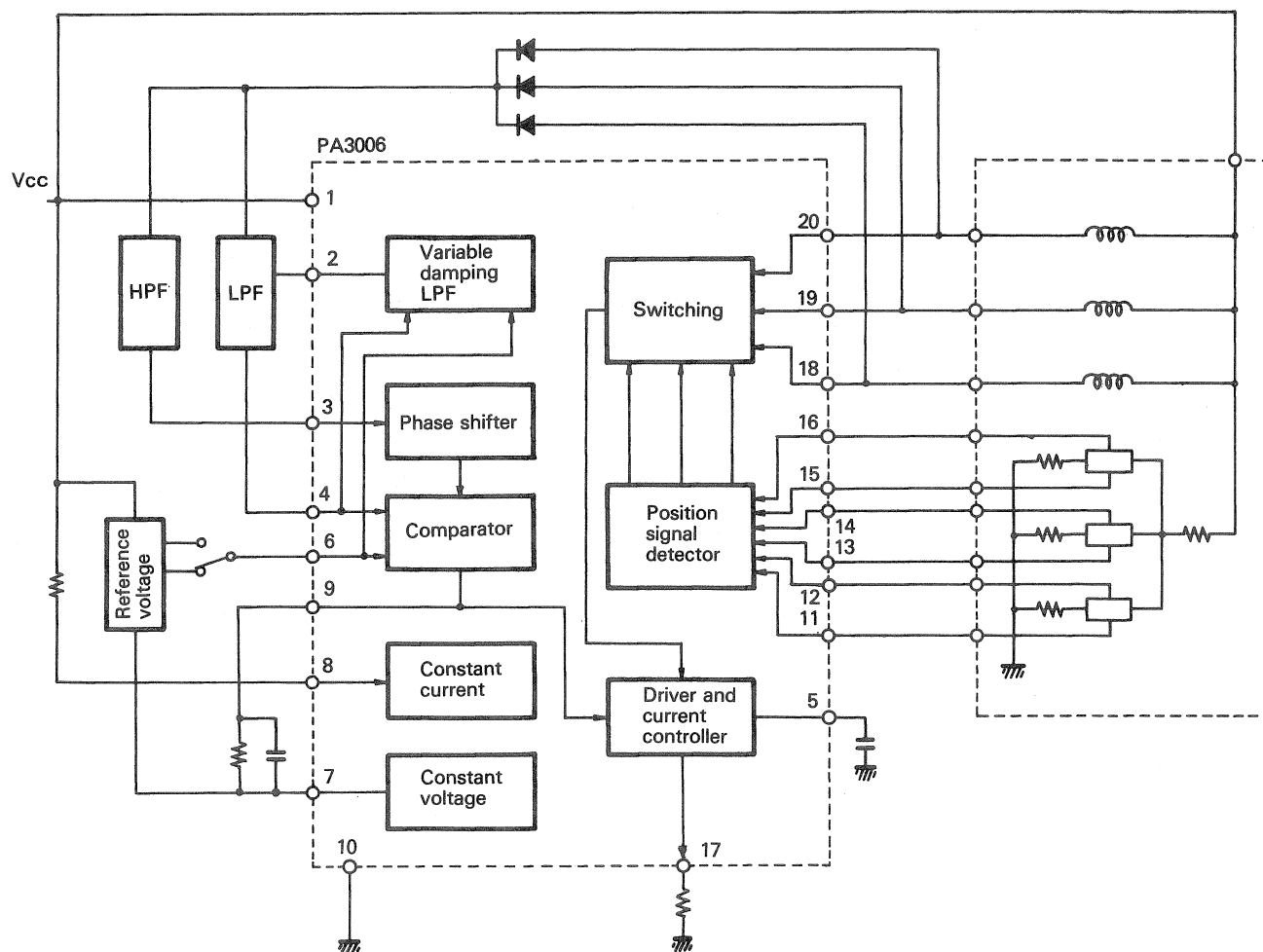


Fig. 5 Block diagram of E-servo DD motor

**(a) Variable damping LPF**

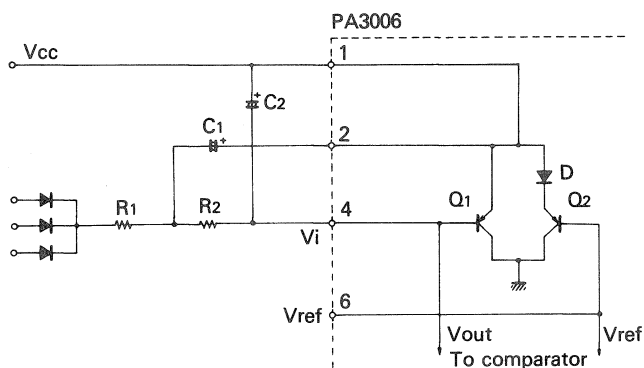
This circuit improves the stability of the servo operation by varying the LPF's damping coefficient. An active type of LPF is used to improve both the response characteristics and the wow/flutter. This active LPF performs a double task: it improves the response characteristics and also reduces wow/flutter with a sharp attenuation characteristic.

However, there is a problem in using this active LPF.

Good response characteristics induce overshoot as shown in Fig. 7(a). This overshoot makes the servo operation unstable and in extreme cases it may not be possible to control the operation at all (poor stability).

This variable damping LPF improves response characteristics and the stability by detecting the overshoot and varying the damping coefficient.

The basic circuit is shown in Fig. 6



**Fig. 6 Basic circuit of variable damping LPF**

The speed detection voltage ( $V_i$ ) which has passed through the LPF ( $C_1, C_2, R_1, R_2$ ) is supplied to the base of  $Q_1$  in the differential circuit while the reference voltage ( $V_{ref}$ ) in line with the rotational speed is supplied to the base of  $Q_2$ . The cut-off frequency of this circuit is determined by  $C_1, C_2, R_1$  and  $R_2$ , and the damping coefficient is determined by  $C_1, C_2, R_1, R_2$  and by the gain (less than 1 for emitter follower type) of the differential circuit. The damping coefficient is therefore varied by the ON/OFF action of  $Q_1$ .

Let's look at the operation of the circuit.

When the motor starts to rotate, the  $Q_1$ 's base voltage is low and it is set to ON since bias is applied. Even when a constant speed is reached, the  $Q_1$ 's and  $Q_2$ 's base voltages are the same but since a diode (D) is inserted into the  $Q_2$ 's emitter,  $Q_1$  goes ON and  $Q_2$  OFF so that the gain of the differential circuit is 1.

When  $V_i$  (overshooting voltage) with a value exceeding the diode's forward voltage  $V_f$  (0.6 V) is applied to the  $Q_1$ 's base,  $Q_1$  goes OFF,  $Q_2$  goes ON and the gain of the differential circuit is reduced to zero.

When  $V_{ref}$  is equivalent to  $V_i$  and  $V_f$ , the operation is unstable,  $Q_1$  and  $Q_2$  are set between the ON and OFF modes, and the gain of the differential circuit may be assumed to be 0.5.

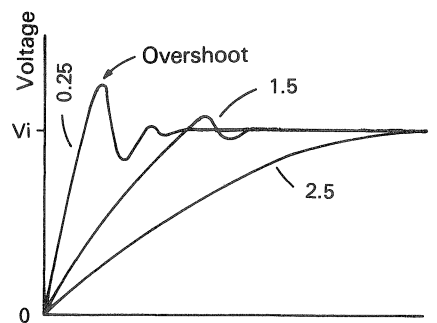
By varying the gain of this circuit, the damping coefficient of the LPF is varied.

But why is the stability improved by varying the damping coefficient?

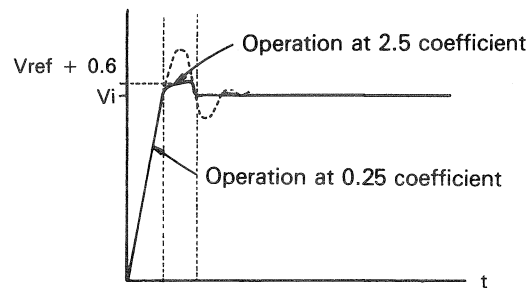
Refer to Fig. 7. If the response characteristics are good, the  $V_i$  rises fast but overshoots and makes the servo operation unstable.

By increasing the damping coefficient when overshoot appears as in Fig. 7(b), the  $V_i$  rise is suppressed and overshoot is prevented. This means that by preventing overshoot, the stability is improved without sacrificing the response characteristics.

The actual damping coefficient is 0.25 at the start of rotation and at constant-speed rotation, 1.5 with an overshoot of 0.6 V and 2.5 with an overshoot of more than 0.7 V.



**(a) Difference in voltage rise time due to differing damping coefficient**



**(b) Variable damping operation**

**Fig. 7 Characteristics of variable damping LPF**

#### (b) Phase shifter

The frequency of the ripple contained in the speed detection voltage is extremely low (6.6 Hz at 33-1/3 rpm), while as already mentioned, the cut-off frequency of the LPF cannot be made very low. This means that it is not possible to sufficiently eliminate the ripple, and if this cannot be done, the wow/flutter increases.

In order to reduce the ripple and the wow/flutter, ripple whose dc components have been removed is fed via a high-pass filter into the current intake circuit of a differential amplifier which composes the comparator mentioned in (c), and it is added with the speed detection voltage applied to this differential amplifier via LPF.

Through this action, the residual ripple of the rotational speed-control voltage is reduced and the wow/flutter is also in turn reduced.

The phase shifter is provided since ripple phase compensation is required for the adding.

#### (c) Comparator

This circuit serves to compare the reference voltage set in line with the rotational speed, with the speed detection voltage and puts out a control voltage for controlling the current flowing to the motor drive coil.

#### (d) Constant-current circuit

This serves as the source for the various bias currents of the circuits inside the IC and its current is determined by the externally mounted resistor.

#### (e) Constant-voltage circuit

This circuit is used to generate the reference voltage for the rotational speed control. It is a temperature-compensating type and so speed drift with respect to fluctuations in the temperature is reduced to the bare minimum.

The actual reference voltage for the rotational speed control is determined by a voltage divider circuit (reference voltage generator circuit) externally mounted to provide the reference voltage in line with the objective, and also by the constant-voltage circuit.

#### (f) Other circuits

The other circuits in the drive system work in almost the same way as the circuits which do not use an IC, and so details of their operation are omitted here.

### 3-2. F-servo DD-motor operation

The ICs used in this circuit are the PA2004 for control and the PA2005 for drive.

This system is used in the PL-200, PL-250, PL-255 and PL-260 turntables.

Fig. 8 is a block diagram of the system.

The frequency generated by the FG in line with the rotational speed of the motor is converted into a dc voltage by the F-V converter, compared with the reference voltage, the current flowing to the drive coil is controlled by the difference, and then the rotational speed is kept at a constant level.

The operation of the ICs is now described in detail.

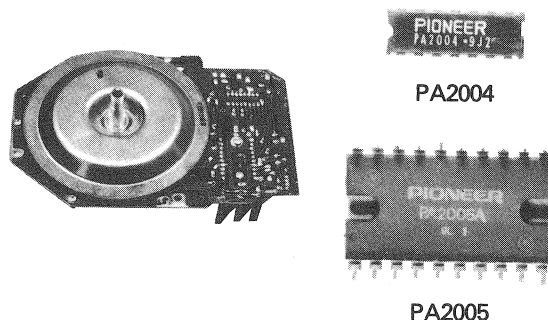


Photo 3 Motor unit and ICs

#### 3-2-1. PA2004

This IC is used for control. It consists of an F-V converter which converts the frequency signal from the FG into a dc voltage and of a reference voltage generator.

Unlike conventional systems, this F-V converter employs a sample and hold system.

With the conventional systems, the converter output is obtained in pulse-width-modulated form and unless this output is converted into dc, it is not possible to control the current flowing to the drive coil.

This requires the services of an LPF. An active LPF with excellent damping characteristics is employed to yield the required signal-to-noise ratio. Since the LPF is inserted directly into the control loop, its phase delay has an effect on the performance.

With the sample and hold system, dc conversion can be made without using the LPF and so there are no side effects of the LPF and the performance is greatly improved.

A brief description of the sample and hold circuit is given before the operation of the IC is detailed.

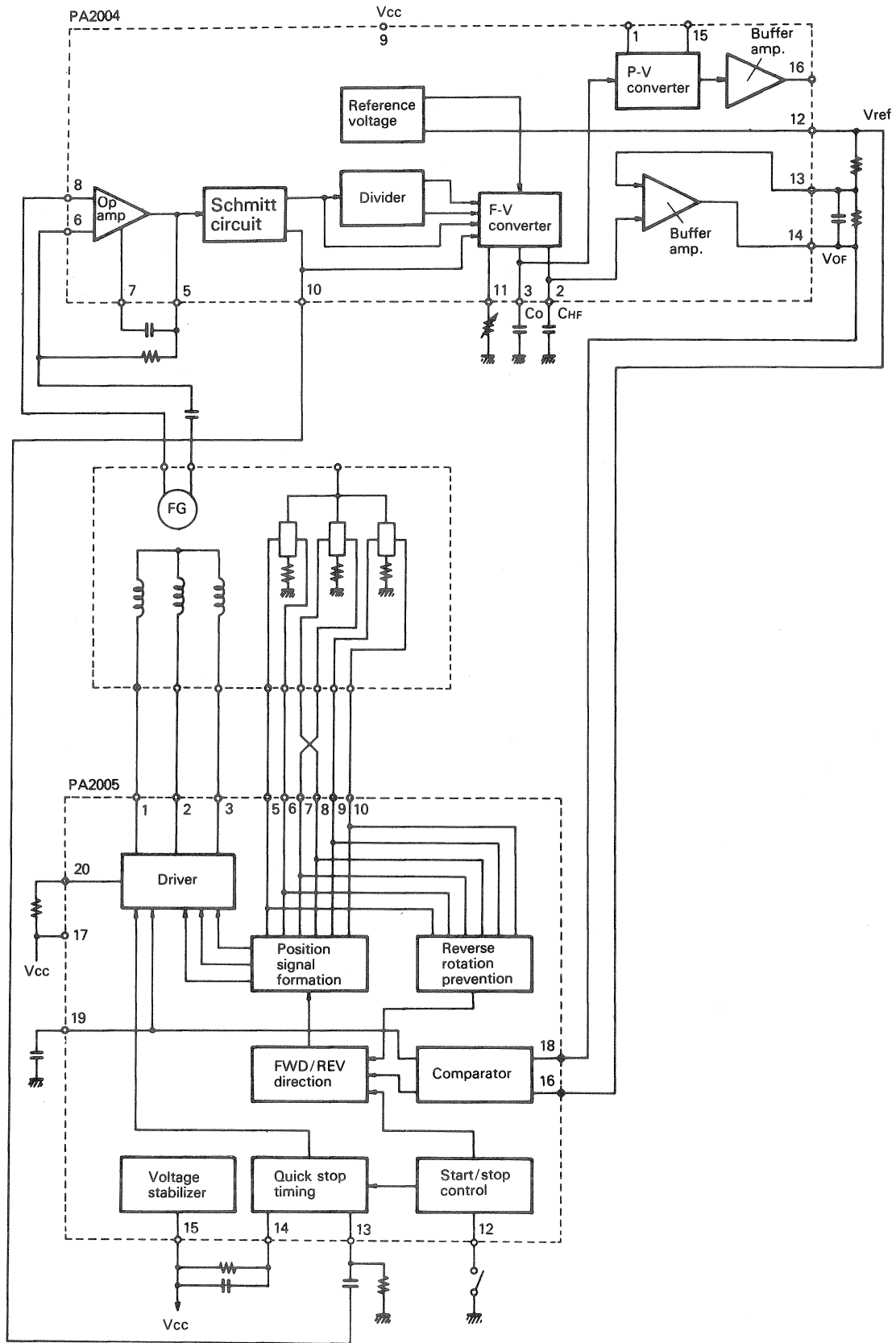


Fig. 8 Block diagram of F-servo DD-motor

Fig. 9 shows the basic circuitry.

A sawtooth waveform is supplied to the circuit as its input. When switch S is closed, capacitor C is charged up to the input voltage.

Even when switch S is open, there will be no discharge since this is a high input impedance buffer amplifier. (Strictly speaking, an input current flows even with such an amplifier and so there will be a slight discharge.) Therefore, a charged voltage appears at the output and it is held until the switch next closes.

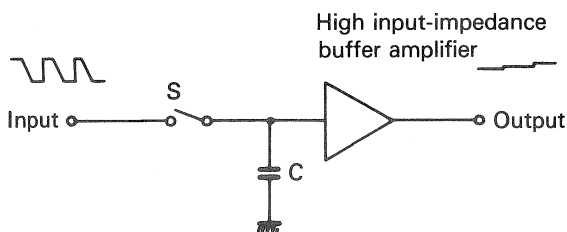


Fig. 9 Basic sample and hold circuit

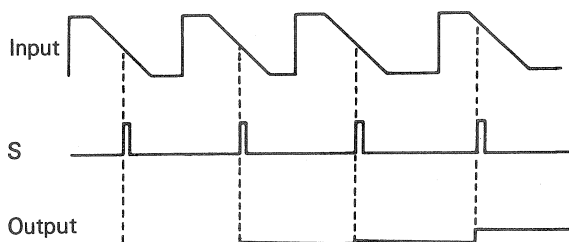


Fig. 10 Operation waveform

Since a sampling signal is supplied to switch S and the output signal is held, this is called a sample and hold circuit.

Fig. 10 shows the operation waveform.

As long as the input frequency (or phase) or the sampling frequency (or phase) does not change, a constant dc voltage with minimal ripple can be obtained at the output.

The operation of the PA2004 is now described.

Fig. 11 is a detailed block diagram of the PA2004.

(a) OP amp

Since the speed detection signal from the FG has an extremely low level (1—2 mVrms), it is amplified by the op amp which has band-pass characteristics provided by the resistors and capacitors of the input circuit and feedback circuit. The waveforms are shaped by the diode limiter and put out.

The band-pass characteristics are provided to prevent the servo operation from becoming unstable due to extraneous noise.

(b) Schmitt circuit

It is impossible to obtain perfect square waves with the diode limiter in the previous stage. The Schmitt circuit serves to shape the waveforms into square waves and safeguard against malfunction due to extraneous noise.

There are two outputs, one with a positive phase and the other with a negative phase, and these become the gate pulses of the F-V converter.

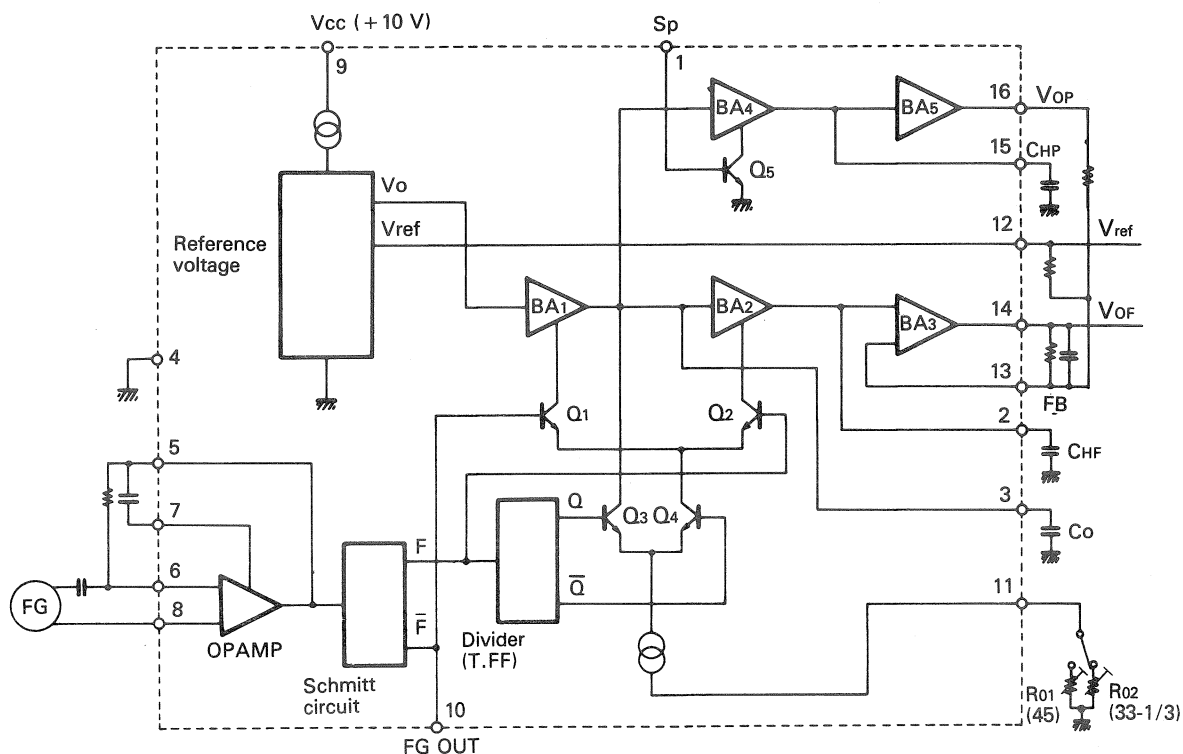


Fig. 11 Block diagram of PA2004

(c) Frequency divider circuit

The positive phase output of the Schmitt circuit is supplied to this circuit where its frequency is halved. Its outputs also are positive and negative phases, and they become the gate pulses of F-V converter.

(d) Reference voltage generator

This circuit generates two types of reference voltage, one ( $V_o$ ) for the sample and hold circuit and the other ( $V_{ref}$ ) for the comparator.

(e) F-V converter

This circuit serves to convert the frequency from the FG into DC voltage, and it consists of buffer amplifiers ( $BA_1$  through  $BA_3$ ), switching transistors ( $Q_1$  through  $Q_4$ ) to drive the buffer amplifier and capacitors.

The output of Schmitt and frequency divider are supplied to the input and using these signals (square waves of the frequency corresponding to the rotational speed), a dc voltage is obtained at the F-V converter's output.

Fig. 12 is a timing chart (waveforms).

First, when the Schmitt circuit output  $F$  and the frequency divider output  $Q$  are low,  $\bar{F}$  is H and  $\bar{Q}$  is H, and so bias is supplied to  $Q_1$  and  $Q_4$ , and  $BA_1$  is activated as soon as  $Q_1$  and  $Q_4$  are set to ON. The reference voltage ( $V_o$ ) for the sample and hold circuit is charged in the capacitor ( $C_o$ ) for sawtooth wave generation.

Next, when  $F$  shifts to H ( $F : L$ ),  $Q$  shifts to H ( $Q : L$ ) and so  $Q_3$  goes ON and  $C_o$  starts discharging at a constant current.

Since  $\bar{Q}$  is L,  $Q_4$  goes OFF and  $BA_1$  and  $BA_2$  do not operate. Then,  $C_o$  discharges through  $Q_3$  alone.

Even when  $F$  shifts to L ( $\bar{F} : H$ ),  $Q_2$  turns OFF and  $Q_1$  turns ON, the output of the frequency divider does not change. So,  $Q_4$  is OFF and  $BA_1$  and  $BA_2$  do not operate. The discharging continues.

When  $F$  shifts to H ( $\bar{F} : L$ ), the frequency divider outputs are inverted to  $Q = L$  ( $\bar{Q} = H$ ).  $Q_3$  is now OFF and so the  $C_o$  stops discharging and  $Q_2$  and  $Q_4$  turn ON. Then,  $BA_2$  operates and the voltage produced when  $C_o$  completes discharging is transferred to holding capacitor  $C_{HF}$ .

Next, when  $F$  shifts to L,  $Q_2$  turns OFF and  $Q_1$  ON.  $BA_1$  operates and  $C_o$  is charged up to  $V_o$ .

The charge of holding capacitor ( $C_{HF}$ ) is held in its former state until the  $F : H$  ( $\bar{F} : L$ ) and  $Q : H$  ( $\bar{Q} : L$ ) conditions are satisfied.

This is how the F-V conversion operates.

The  $C_{HF}$  voltage is supplied to the comparator via the  $BA_3$  buffer amplifier as the rotational speed detection dc voltage ( $V_{OF}$ ).

The resistor and capacitor inserted between pins 13 and 14 compose a feedback type low-pass filter by feeding  $BA_3$ 's inverted output back to input via this RC combination. The F-V converter is thus based on a sample and hold circuit in which the  $F = H$  and  $\bar{Q} = H$  states are sampled and the  $C_{HF}$  potential is fed out.

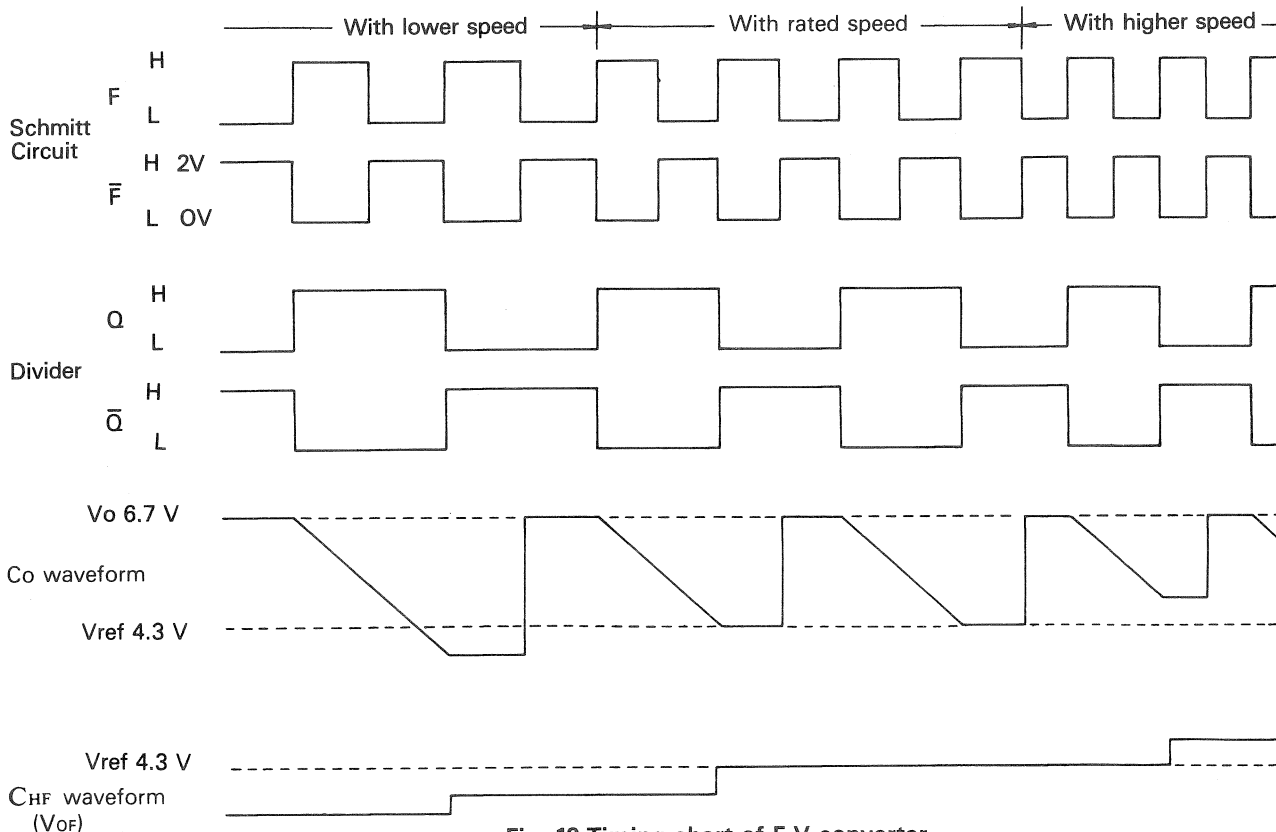


Fig. 12 Timing chart of F-V converter

Pin 11 of PA2004 is the terminal that determines the Co discharging current. This is because the discharging time must be adjusted so that  $V_{OF}$  and  $V_{ref}$  are brought to the same level under rated speed conditions.

If the discharge current during high-speed rotation is the same as that during low-speed rotation,  $V_{OF}$  becomes higher than  $V_{ref}$  as shown in Fig. 12. Then, the voltages are compared by the comparator, the  $V_{OF} - V_{ref}$  component makes the servo system work to get low-speed rotation. In other words, high-speed rotation cannot be obtained.

$V_{OF}$  must be set to the same level as  $V_{ref}$  for high-speed rotation. It is thus necessary to increase the discharge current and shorten the discharge time of  $C_o$ . (Refer to Fig. 13)

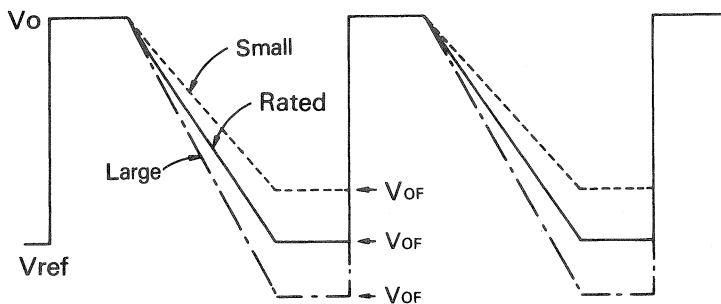


Fig. 13 Difference in  $V_{OF}$  according to  $C_o$  discharge current

(f) P-V converter

This circuit is not employed in F-servo system.

It is, however, a feature of quartz PLL servo systems and so it is detailed here. It consists of  $BA_4$ ,  $BA_5$ ,  $Q_5$  and  $C_{HP}$ , samples the phase of the rotational speed frequency with the reference frequency from the quartz oscillator and converts the phase difference into dc voltage.

Let's look at the actual operation.

Just as with the F-V conversion, the charged voltage of capacitor ( $C_o$ ) for generating the sawtooth waveforms is sampled and a dc voltage output is obtained.

Fig. 14 is the waveform timing chart.

The sawtooth waves enter  $BA_4$ . When the reference frequency pulse is supplied,  $Q_5$  turns ON and  $BA_4$  is activated so that the holding capacitor ( $C_{HP}$ ) is charged up to the input pulse voltage. The  $C_{HP}$  potential ( $V_{op}$ ) passes through  $BA_5$  and  $R$ , enters the inverting input of  $BA_3$ , is mixed with  $V_{OF}$  and put out as  $V_{OF}$ . The potential is fed to the  $BA_3$ 's inverting input since  $V_{OF}$  must be increased to a value higher than  $V_{ref}$  just as in high-speed rotation with the F-V converter when the phase advances. As seen from the timing chart, the center of the sawtooth wave's slanted section is made to be the reference point and so the P-V converter output is made  $(V_o - V_{ref})/2$  higher than the F-V converter output.

For this reason, the level is shifted by  $BA_5$  to make it the same as that of  $V_{OF}$ .

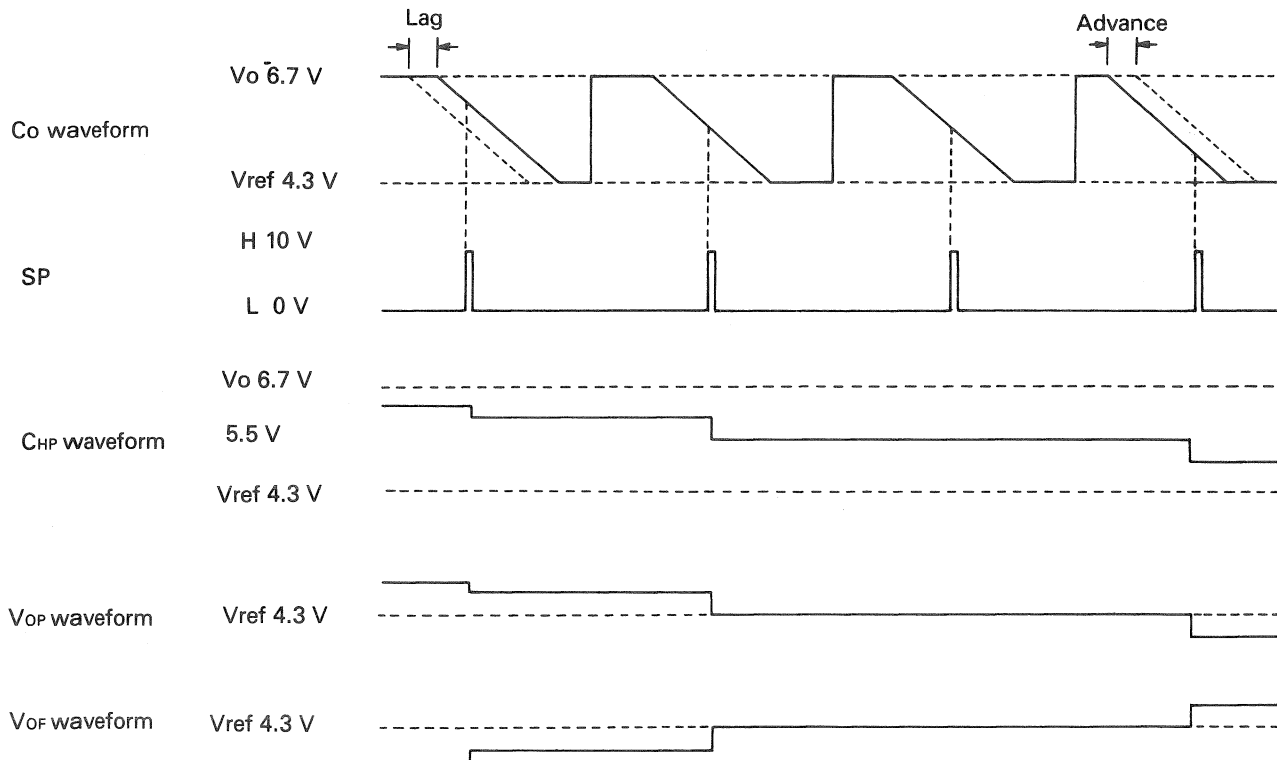


Fig. 14 Timing chart of P-V converter

### 3-2-2. PA2005

This is a power amplifying IC for rotating the motor. It serves to compare the rotational speed detection voltage ( $V_{OF}$ ) with the reference voltage supplied by PA2004 and uses the difference between the voltages to control the current flowing to the drive coil so that the rotation remains constant. It also has various accessory circuits.

A detailed description of the IC's drive system is given in Service Manuals.

Let's look at the click-stop circuit here.

Fig. 15 is a block diagram of the PA2005.

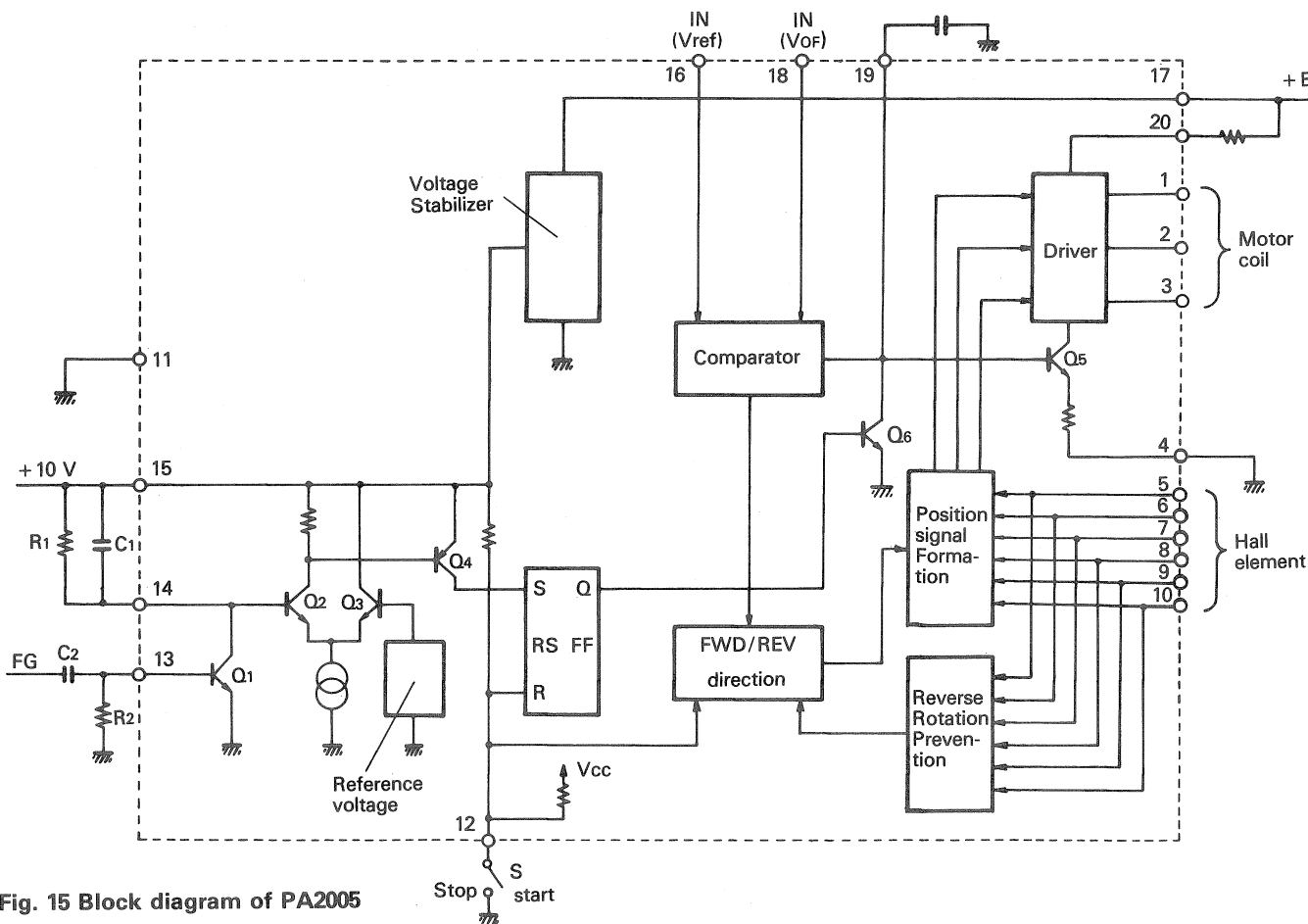


Fig. 15 Block diagram of PA2005

When the power switch is pushed ON and  $V_{cc}$  is supplied to the IC, the start/stop switch (S) is still at the stop position (pin 12 is grounded : L level), the motor does not rotate. The FG output (pin 10 of PA2004) is dc voltage only and the RS flip-flop (latch) inputs are R : 1 and S : H ( $Q_1$  is OFF since the dc component is cut off by the  $C_2$  and  $R_2$  high-pass filter and no bias is supplied;  $Q_2$  turns ON since bias is supplied from  $R_1$ ; and  $Q_4$  turns ON), and so output Q is set to H (refer to Fig. 16).

Fig. 16 Table of RS flip-flop functions

Input		Output
S	R	Q
L	L	Unchanged
L	H	L
H	L	H
H	H	L*

\* This output cannot be used because this time Q and  $\bar{Q}$  become L and outputs depend on timing and are unknown when SR shifts from HH to LL.

The Q "H" output enters the base of  $Q_6$ , turning  $Q_6$  to ON, and the drive current control voltage supplied to the base of  $Q_5$  is grounded so that no current flows to the drive coil and the motor does not rotate.

When switch S is set to START, RS flip-flop input R is set to H since it has a pull-up resistor. Inputs R and S are both set to H and output Q is at L and  $Q_6$  turns OFF. Then, the drive current control voltage is supplied to the base of  $Q_5$ , current flows to the drive coil and the motor starts rotating.

Once the motor starts rotating, the FG output signal (PA2004 Schmitt circuits reverse phase output) passes through the  $C_2$  and  $R_2$  differential circuit (HPF) and enters the base of  $Q_1$ . This makes  $Q_1$  go ON and OFF while  $C_1$  is repeatedly charged and discharged.



The Q<sub>2</sub> base potential falls and so differential comparator Q<sub>2</sub> goes OFF (Q<sub>3</sub>: ON) and Q<sub>4</sub> goes OFF. RS flip-flop input S shifts to L while input R is H and output Q is kept at L. So the motor keeps rotating.

Now when the switch S is set to STOP, RS flip-flop input R goes to L and output Q does not change but remains at L. The motor keeps rotating as a result.

However, since this L signal enters the FWD/REV direction and a counter torque is generated, the motor's rotational speed falls.

As this speed approaches zero, the FG output frequency drops, the Q<sub>1</sub>'s ON/OFF cycle is extended and the C<sub>1</sub> discharge time is prolonged. Then, the Q<sub>2</sub> base potential starts to rise. When it becomes higher than the Q<sub>3</sub> reference voltage (V<sub>s</sub>), Q<sub>2</sub> goes ON (Q<sub>3</sub>: OFF) and Q<sub>4</sub> goes ON so that RS flip-flop input S is set to H and output Q is set to H.

Q<sub>6</sub> now goes ON and no more current flows to the drive coil. The motor stops and any slight remaining rotation is caused by inertia.

Fig. 17 is a timing chart of the major section from the time the motor is rotating till it stops.

Some models do not employ this circuit. If the circuit is not employed, pins 12 and 14 are open and pin 13 is grounded. In other words, RF flip-flop input S is L and R is H and so output Q is L and Q<sub>6</sub> goes OFF. This means that when the power is switched on, the motor starts rotating and that the current no longer flows to the drive coil when the power is switched off. Since the rotational speed cannot be slowed down quickly by counter torque, the platter continues rotating for a short period of time due to its inertia.

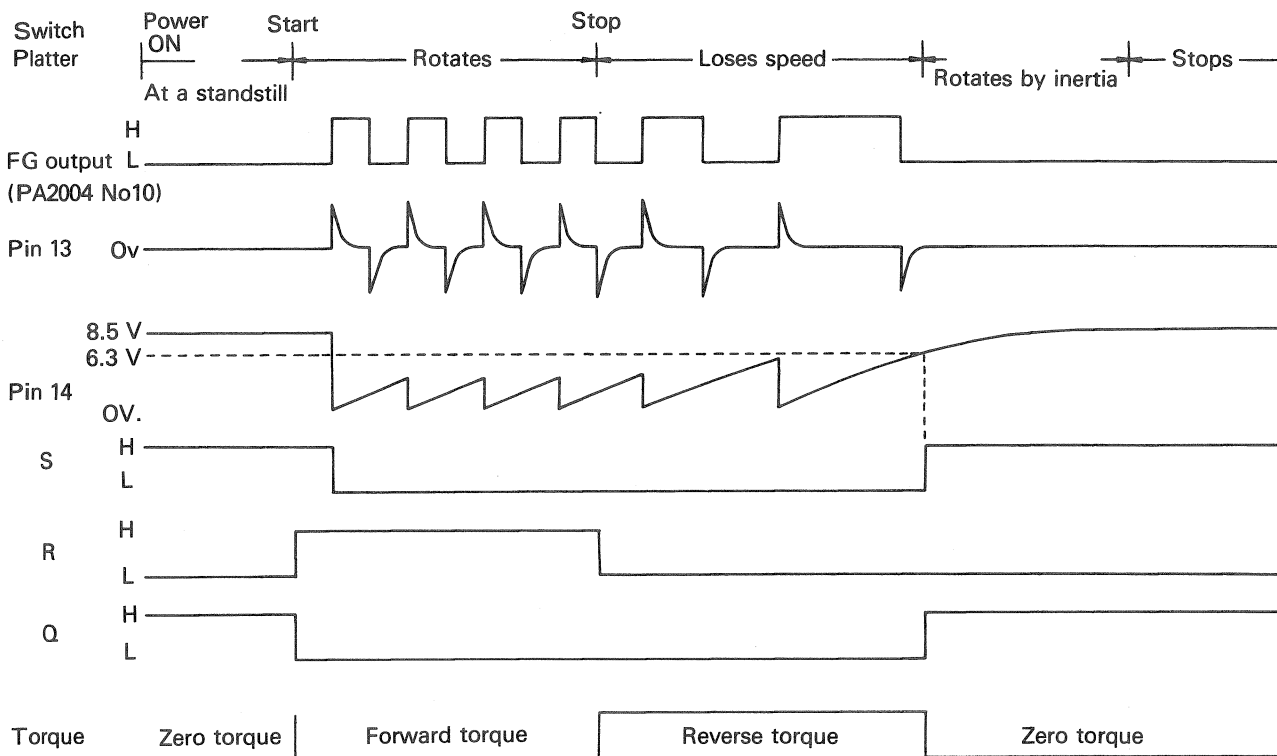


Fig. 17 Timing chart of quick-stop circuit

### 3-3. Quartz PLL servo DD motor operation

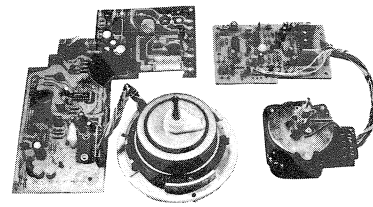
The ICs used in this circuitry are the PD1003 for generating the reference signal, the PA2004 for control and the PA2005 for driving.

This system is adopted by the PL-300, PL-400, PL-500, PL-600 and PL-L1000 turntables and also by the CT-F1250 cassette deck.

As can be seen in the Fig. 18 block diagram, this system has a phase comparator and a quartz oscillator in addition to the frequency comparator of F-servo system.

Details on the operations of the PA2004 and PA2005 were given with the F-servo and so this section concentrates on the PD1003 IC, the reference signal generator.

Fig. 19 is a block diagram of the PD1003.



PD1003      PA2004      PA2005

Photo 4 Motor unit and ICs

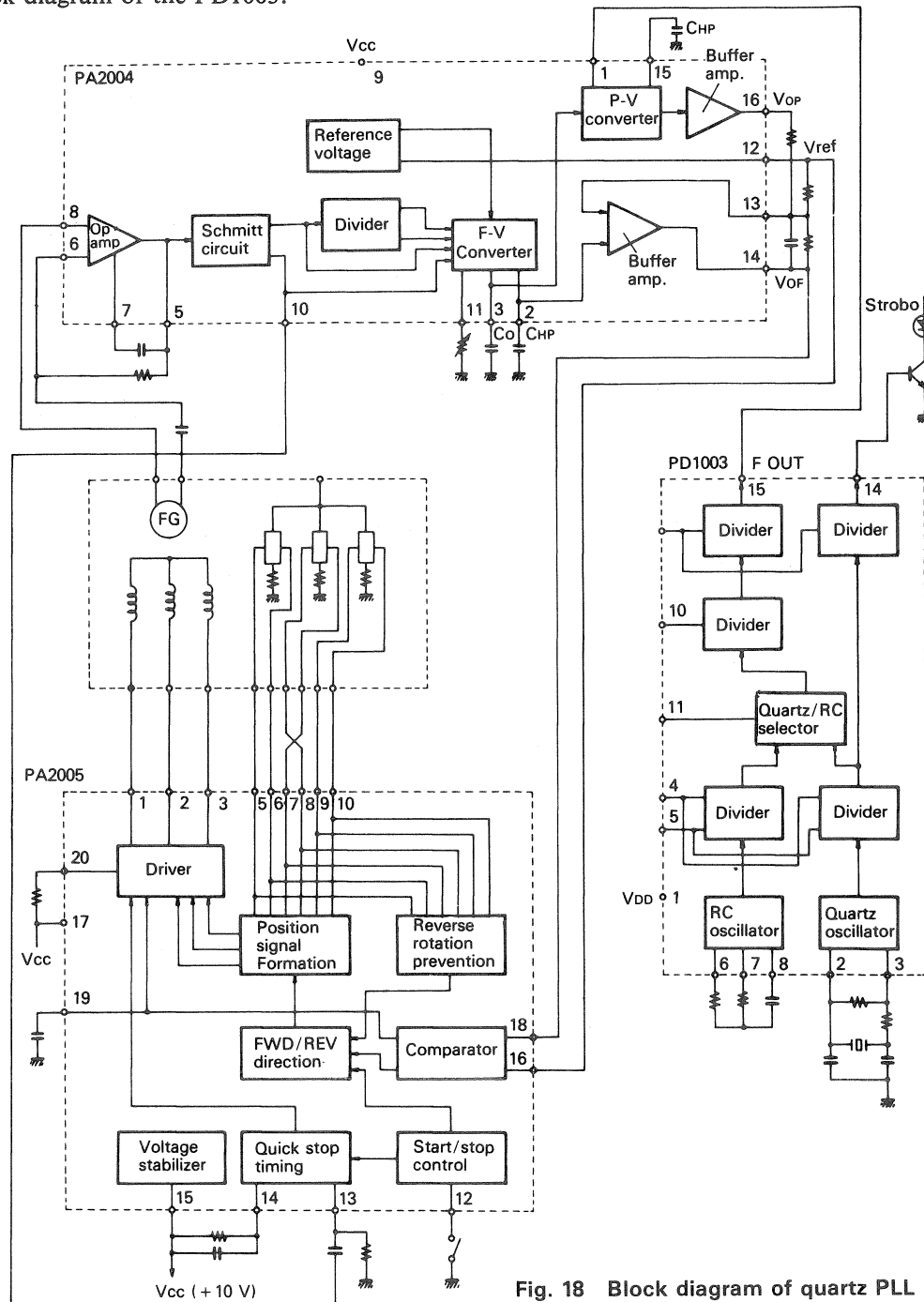


Fig. 18 Block diagram of quartz PLL DD motor

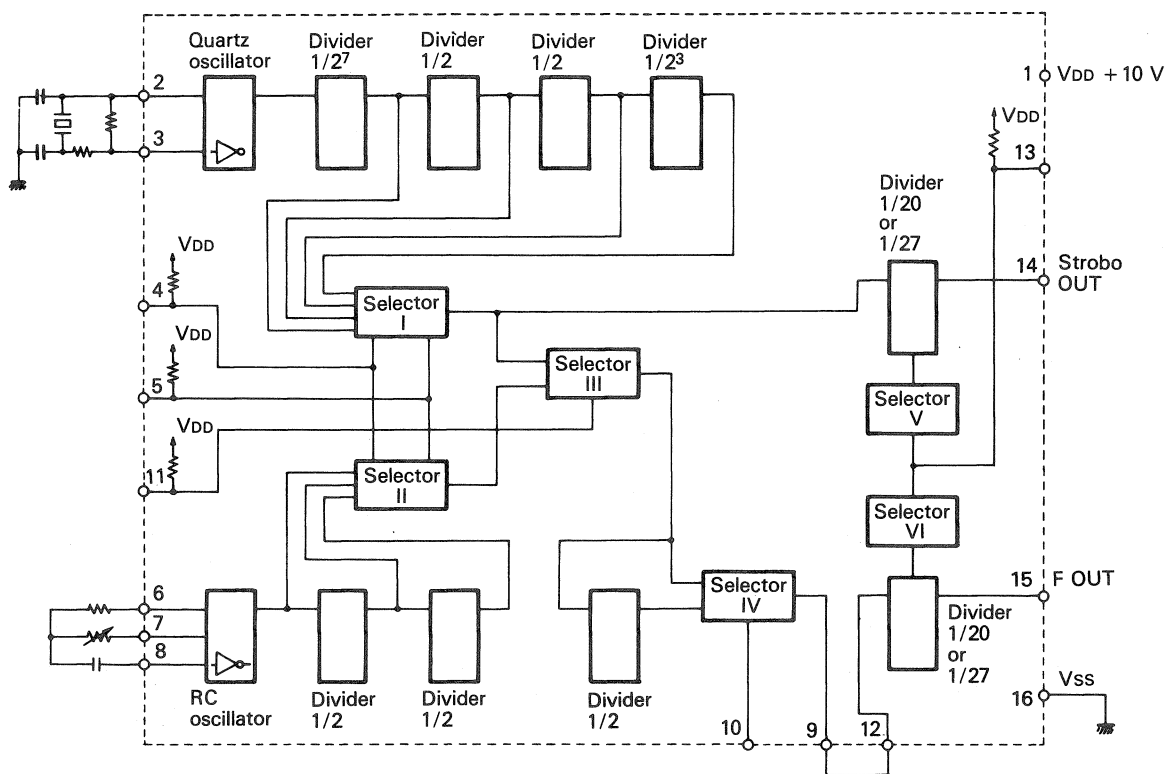


Fig. 19 Block diagram of PD1003

As shown in the diagram, this IC is a digital IC consisting of a quartz and RC oscillators, frequency divider and a selector for selecting the frequency division ratio. Depending on the design concept, some circuits in the IC are left unused in some models. This will be explained with respective models.

**(a) Quartz oscillator**

This consists of gates and a quartz crystal which is connected to pins 2 and 3 and generates a signal. In the turntables the oscillation frequency is 6.144 MHz; in the CT-F1250 cassette deck it is 6.196 MHz.

**(b) RC oscillator**

This circuit consists of gates, resistors and a capacitor. Its oscillation frequency is determined by the resistors and capacitor connected to pins 6, 7 and 8, and this may be varied by a variable resistor.

The frequency produced by the quartz oscillator is constant at all times and so it is impossible to adjust the rotational speed continuously with this alone. So, the RC circuit is used when the rotational speed is to be controlled as in the pitch controller in CT-F1250. This is not quartz PLL servo but ordinary PLL servo. The reference oscillation frequency in the CT-F1250 is 48.4 kHz.

In the latest quartz PLL servo turntables, there is no speed control and so this circuit is not used. When this circuit is not used in order to prevent malfunctions caused by extraneous noise, pin 6 is set to L (ground) or pin 7 is set to H (V<sub>DD</sub>).

**(c) Selector I**

This circuit is composed of gates, it is activated by the input signal from pins 4 and 5 and it determines how the output signal of the quartz oscillator should be divided. A pull-up resistor is connected to pins 4 and 5. If the terminals are opened, their inputs are set to H; if they are grounded, the inputs are set to L. Selection is as below.

- Frequency division of 1/4096 (1/2<sup>12</sup>) with 4:H, 5:H
- Frequency division of 1/128 (1/2<sup>7</sup>) with 4:L, 5:H
- Frequency division of 1/512 (1/2<sup>9</sup>) with 4:H, 5:L
- Frequency division of 1/256 (1/2<sup>8</sup>) with 4:L, 5:L

Pins 4 and 5 are left open on the turntables so that the signal frequency is divided down by 1/2<sup>12</sup> or 1/4096 from 6.144 MHz to 1.5 kHz.

In the CT-F1250 deck pin 4 is left open while pin 5 is grounded so that the signal frequency is divided down by 1/512 or 1/2<sup>9</sup> from 6.196 MHz to 12.1 kHz.

**(d) Selector II**

Just as with Selector I, this circuit is activated by the pin 4 and 5 input signals. It serves to determine the frequency division ratio of the RC oscillator's output signal.

No frequency division, output is unchanged with 4:H, 5:H

- Frequency division of 1/4 (1/2<sup>2</sup>) with 4:H, 5:L
- Frequency division of 1/2 (1/2) with 4:L, 5:L

The turntables explained in this chapter do not use the RC oscillator but in the CT-F1250 deck, pin 4 is left open while pin 5 is grounded so that a 1/4 frequency division is made.

The signal is divided from 48.4 kHz to 12.1 kHz.

**(e) Selector III**

This circuit is activated by the pin 11 input signal, and it selects the divided output of the quartz or RC oscillator. Thus, the input at pin 11 determines the servo system to be operated, Quartz-PLL or PLL.

As a pull-up resistor is connected also to pin 11, its level is set to H when opened, resulting in quartz PLL servo operation. PLL operation results when this pin is grounded and set to L.

The turntables feature only the quartz PLL servo operation and so pin 11 is left open while in the CT-F1250 the selector is provided.

**(f) Selector IV**

This circuit selects whether the signal should pass through the frequency divider (1/2) or be supplied directly to interim output pin 9.

Let us now consider the winking of the stroboscope. A stroboscope is such that when the rotational speed and the winking of the stroboscope are perfectly synchronized, the stripe around the platter appears to stand still. The output reference frequency of PD1003 at 33 1/3 rpm is 27.78 Hz. If the winking frequency is too low, the strobo stripes will be hard to see.

Therefore, this circuit is inserted to double the reference frequency (the number of stripe divisions is also doubled).

In accordance with the pin 10 input, this selects either 1/2 frequency division or direct passage. A pull-up resistor is not provided at pin 10 and so connection must be made to VDD in order to set it to H. With H 1/2 frequency division is selected. The CT-F1250 deck does not require a stroboscope output and so this selector is used only for frequency division.

**(g) Selector V and VI**

This circuit selects the 1/20 or 1/27 divider with the input signal of pin 13. In the case of a turntable, selection is made between 45 or 33-1/3 rpm output frequencies.

Square waves with a 50% duty are useless for this divider to get the sampling signal for strobo lighting and phase controlling so conversion is made into pulse waveforms by reducing the duty ratio. (Refer to Fig. 20).

As a pull-up resistor is attached to pin 13, when this is open, the input is set to H and a 1/20 frequency division is selected and when the pin is grounded a 1/27 frequency division is selected.

At the 45 rpm turntable speed, the selector I output is 1.5 kHz and so it is divided by 1/20 and a 75 Hz output is obtained at pin 14. The 750 Hz signal which has been made by selector IV and 1/2 divider is further 1/20 frequency divided to produce a 37.5 Hz output at F Out (pin 15).

At 33-1/3 rpm the frequency division is 1/27 and so a 55.555... (55.56) Hz output appears at strobo out and a 27.777... (27.78) Hz output appears at F Out.

The selector III output has a frequency of 12.1 kHz in the CT-F1250 deck. This is further frequency divided by 1/2 in selector IV and then by 1/20 to produce an output of 320.5 Hz at F Out.

The strobo output signal is supplied to the strobo drive circuit which makes the stroboscope wink.

The F out signal is the sampling pulse (reference signal for phase comparison) for the P-V converter in PA2004 IC mentioned in the F servo DD motor section. This signal is combined with the frequency-compared signal to become the rotational speed detection signal.

In this way the PD1003 IC easily selects the oscillators and the frequency division ratio in accordance with the selector input signals and is applicable to various purposes. So it is used not only in turntables but also in tape decks.

When the oscillation frequency of the RC oscillator is to be varied as with the pitch control on the CT-F1250, it is necessary to vary at the same time the discharge current of capacitor Co connected to PA2004 for generating sawtooth waves. Unless the discharge current is varied, the F-servo operation makes the rotation constant and the pitch can no longer be controlled. For this reason, the Co discharge current and the oscillation frequency of the RC oscillator are varied for the pitch control.

The quartz PLL servo system consists of F-servo and phase controllers with a quartz oscillator. So, it should be understood together with the F-servo DD motor's operation (PA2004, PA2005) explained in the previous section.

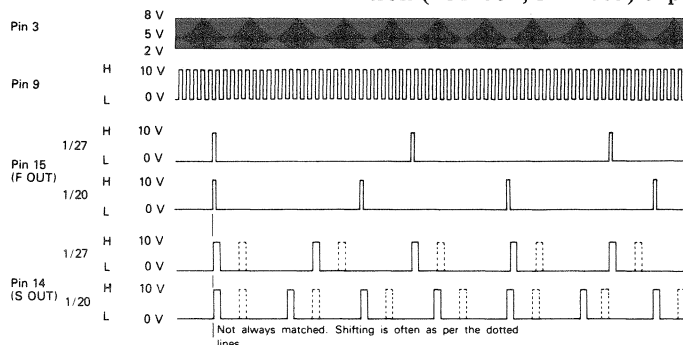


Fig. 20 PD1003 timing chart

#### 4. Checkpoints in Adjustments and Repair Work

##### 4-1. E-servo system (PA3006)

As explained before, the reference voltage and speed detection voltage are both dc voltages with this system. Thus it seems that the rotational speed can be controlled by adjusting either voltage.

However, the speed detection voltage contains ripples which have a great effect on the response characteristics and also the voltage itself varies according to the rotational speed even though this variation is small (increase of 0.2 V when 33-1/3 rpm speed is switched to 45 rpm). Therefore, adjusting this speed detection voltage or, in other words, adding an adjustment part (a semi-fixed variable resistor) to the detecting circuit serves only to invite a deterioration in the performance. Therefore, the adjuster is incorporated into the reference voltage generator in the E servo system.

Refer to the Service Manual of the model concerned for adjuster location (position of the semi-fixed variable resistor).

To adjust, proceed as follows:

- (1) Set the speed control knob on the panel at the center.
- (2) Set the power switch to ON to start the motor rotating. Rotate the 33-1/3 and 45 rpm semi-fixed variable resistors and adjust so that the respective stroboscope pattern appears to stand still as shown in Fig. 21.

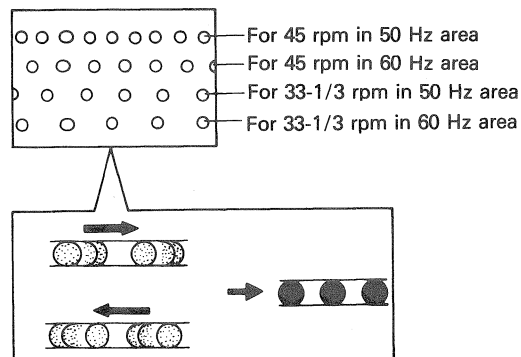


Fig. 21 Stroboscope

This completes the adjustment.

The rotational speed is now fixed through this adjustment.

The stroboscope winks due to the power line frequency and so in areas where the power frequency fluctuates, a check conducted several hours later may let the checker find that the stroboscope pattern is moving and think that the rotational speed has changed. The pattern is moving because the power line frequency is fluctuating and not because the motor's speed has changed. For instance, with a 0.5% fluctuation, the pattern moves for one section in two seconds. Care must be taken since it is easy to get this phenomenon confused with speed drift. To keep the pattern still, frequent turning of the speed control knob is required.

Some doubts may still persist about what reference to use for the adjustment of the rotational speed. The actual fluctuation of the power line frequency is so small (within 0.2% in Japan so that the pattern moves for only one section in 5 seconds) that it is not possible to hear the difference. This means that it is perfectly acceptable to adjust the speed only once.

However, users familiar with instruments who are concerned with the musical steps and frequency may adjust the speed while they listen without paying any attention to the stroboscope.

One point which should be remembered with repair work is that there are some check locations where a conventional multimeter may not be used for measuring the voltage.

When checking the reference voltage or speed detection voltage with a multimeter, the control system is affected by the slight voltage fluctuation caused by the meter and the rotational speed is changed and the correct voltage cannot be measured.

For these voltage measurements a high input impedance DC voltmeter is required.

##### 4-2. F-servo system (PA2004, PA2005)

As explained in the F-V converter section of the PA2004's operation, the rotational speed is adjusted by varying the  $V_{of}$ , or in other words, the  $C_o$  discharge current.

The adjustment method and stroboscope problems are the same as those for the E-servo system.

Bear in mind the following two points during repair work.

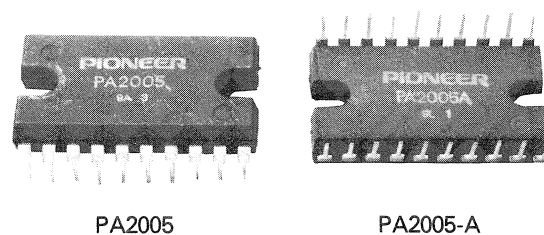
###### (a) Waveform observation is required

This system is controlled by frequency and so this necessitates waveform observation with an oscilloscope. Refer to the timing charts in Fig. 12.

###### (b) There are two types of PA2005

The feet direction differs between the PA2005 and PA2005-A, as shown in Photo 5. Be careful when ordering. (Refer to the Service Manual of the model concerned.)

Photo 5 External appearance of PA2005



PA2005

PA2005-A

Photo 5

#### 4-3. Quartz PLL servo system (PD1003, PA2004, PA2005)

This system is composed of a frequency control circuit and a phase control circuit and so it is necessary that both control circuits be matched. Matching here means adjustment.

As is well-known, the signal, or sampling pulse (SP), from the quartz oscillator has a constant frequency, and there is hardly any drift caused by temperature and humidity.

This system adjust the Co discharge current to let the SPs come to the midpoint of the Co discharge curve as with the F-servo system. (Actually, it is hard to align this midpoint and so adjustment is made with FG OUT, pin 10 of PA2004 [FG OUT]).

The midpoint is the center of the phase control's lock range. Phase alignment also means frequency adjustment.

The signal from the quartz oscillator is used to make the stroboscope wink and so there is no problem of strobo pattern drift due to fluctuation in the power line frequency as in the E-servo and F-servo systems.

What happens then when adjustment is required?

The rotational speed varies and the stroboscope pattern moves very slowly. At one point a stroboscope division jumps right or left when speed is slow or fast.

It happens because the frequency and phase control does not coincide as the rotational speed shifts from its rating along with the change in the Co discharge current.

The frequency control works to control the rotation speed, determined by the Co discharge current not the rated speed while the phase control works to control the rated speed using the sampling pulse. As a matter of course, when the platter is not rotating at its rated speed, the stroboscope pattern moves. However, since the phase control is activated, the speed at which the pattern moves is very slow. (If the adjustment is deviated in the extreme, this speed is fast but with only a slight deviation, the phase control offsets it so that the platter rotates at a constant speed.)

At one point the phase control disengages, the stroboscope pattern jumps and it reengages immediately after.

The adjustment methods are now described.

There are two ways; by observing SP and FG OUT waveforms and by measuring the Vref and Vop voltage.

##### (a) SP and FG OUT waveform observation

This is the best method to adjust the current to the midpoint of the phase control lock range.

It is also mentioned in the Service Manual.

Adjustment by this method is recommended.

To observe the waveforms an oscilloscope is used.

Only a certain type of oscilloscope may be used. As the waveform is pulsive and timing is required, a triggered sweep type of oscilloscope must be used. Ordinary waveform observation can be made with a sync sweep

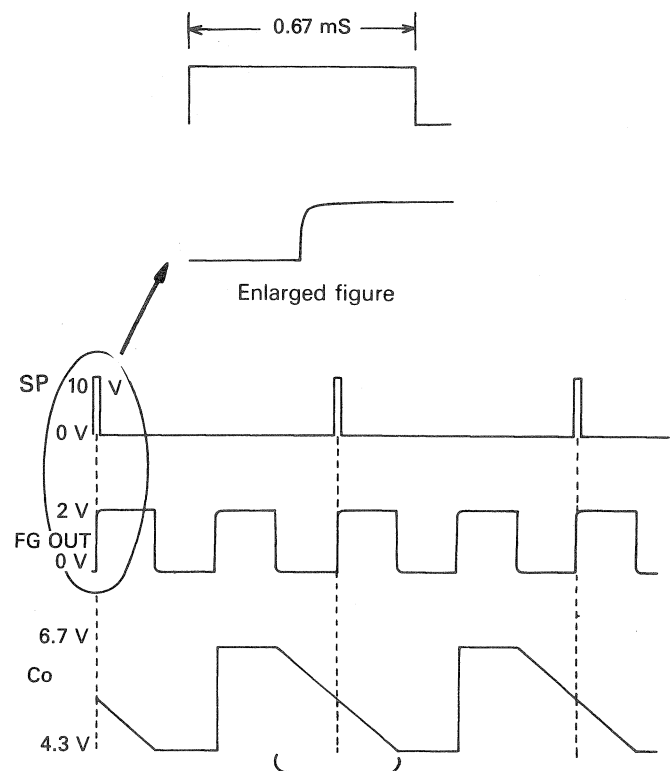
type of oscilloscope but it is impossible to see the timing. A dual-trace oscilloscope is recommended since the timing must be obtained between two waveforms. Adjustment can still be performed, however, with a single-trace oscilloscope and so the methods for both types are given.

Adjustment with dual-trace oscilloscope

Feed the SP (PD1003 pin 15; PA2004 pin 1 or test point) to the CH1 input and the FG OUT (PA2004 pin 10 or test point) to the CH2 input. (Refer to the Service Manual since the positions of the test points and semifixed variable resistors, as well as their numbers, are different according to the model concerned.)

Set the vertical deflection to CHOP and the sync (trigger) to CH1 (SP input) on the oscilloscope.

Now adjust the semi-fixed variable resistors to produce waveforms resembling those in Fig. 22.



If the sampling pulse is within this range, it is covered by the phase control lock and so the motor continues to rotate at its rated speed (adjust to reach the center).

Fig. 22 Timing waveforms

When using an oscilloscope with a low chopping frequency, adjustment cannot be made as in Fig. 22's enlarged figure. In this case, adjust it to the center as far as possible or use the single-trace function and proceed to adjust as follows.

Adjustment with single-trace oscilloscope.

First the SP waveform on internal sync is observed and the pulse width is recorded. The H level width of the SP waveform in Fig. 22's enlarged figure has now been memorized. Next, change over to external sync. The SP signal is fed to the external sync input. The FG OUT signal is supplied to the input, and the semifixed variable resistors are adjusted so that the rising point from L to H is placed in the center of the memorized SP pulse width. Refer to the Operating Instructions of the oscilloscope for more details on its operation.

#### (b) Vref and Vop voltage measurements

The reference voltage (Vref) and phase control voltage (Vop) become equal when the adjustment of the rising point to the midpoint of the phase control lock range is achieved.

The method which makes use of this fact is outlined below.

A multimeter or a dc voltmeter is used to measure the dc voltage. Since the measuring instrument is connected directly to Vref and Vop, the control voltage is affected and deviates from the center of the phase control lock range.

This deviation, however, is small and actually it comes within the phase control lock range. If the trigger-type oscilloscope is not at hand, use this method.

Connect the multimeter's — terminal to pin 12 (Vref) and the + terminal to pin 16 of PA2004.

Adjust the semi-fixed variable resistors to bring the voltage to zero.

Adjust them with a range of about 5 V of the multimeter and then switch over to a low range and adjust again to reach 0 V.

Fig. 23 shows the meter indications at different speeds.

One checkpoint with this method is that a 4.3 V voltage is supplied to the multimeter's — terminal and so this terminal must be floating off the ground, and the turntable's ground connection must be detached.

The multimeter is normally not grounded and so it can be used as it is.

The checkpoints with repair work are the same as those mentioned with the F-servo system.

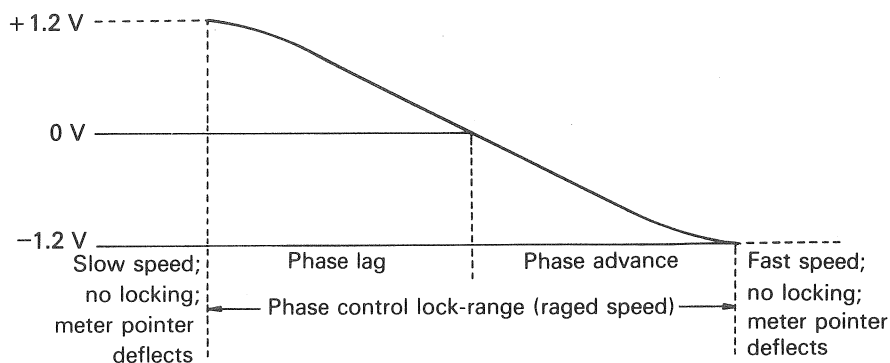


Fig. 23 Meter indications at different speeds

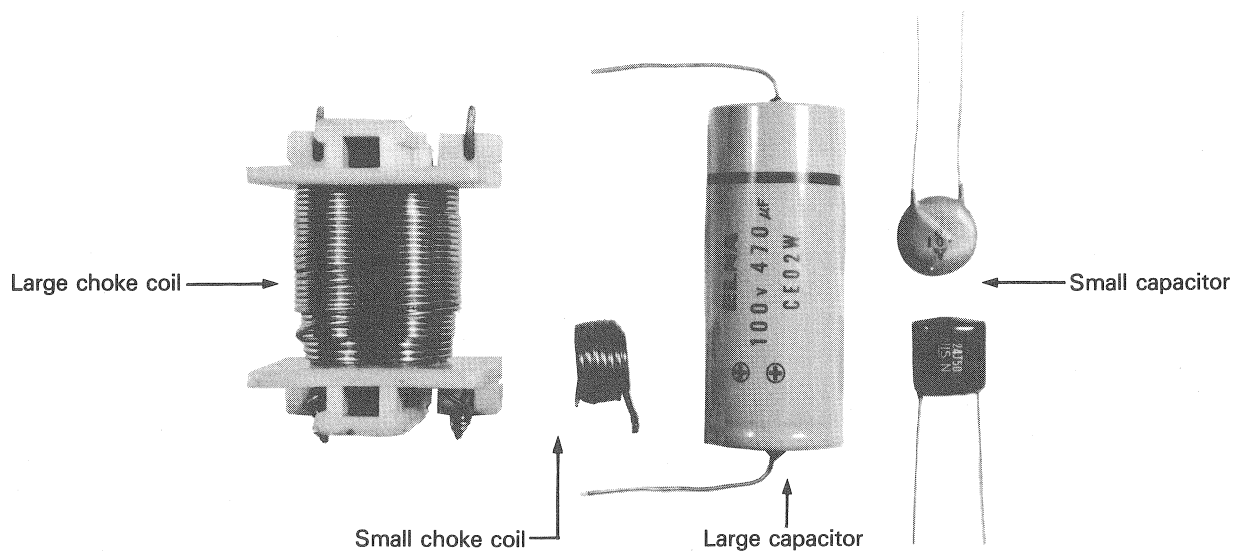
# Basic Theories of Electricity

## Properties of Coils and Capacitors

In the Tuning Fork No. 3, the basic properties of AC current were explained and so in this issue we shall move on to explain about coils and capacitors which are most widely used, along with resistors, in all types of electronic equipment. Unless the basic properties of the elements

which are used in all circuits are known, it is not possible to understand the functions of the circuits involved.

Even with the most complex and sophisticated circuits, understanding begins with the simple basic circuit elements.



### 1. Properties of coils

#### (1) Self-induction effect and inductance of coils

The amount of current flowing in a single conductor connected to both poles of a battery does not change even when the conductor is wound around an insulated iron

core in the shape of a coil. But this does not apply in totality when the conductor is connected to an AC power supply instead of to a battery.

Take a look at Fig. 1.

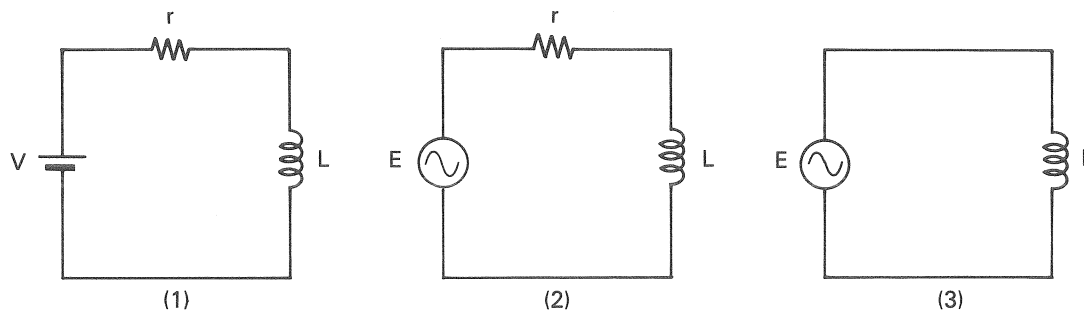


Fig. 1 Current in the coil



First, in circuit (1) the current flowing to the coil can easily be worked out from Ohm's law by  $I = V/r$ . (The DC resistance of coil L is assumed to be zero.)

In circuit (2) an AC power supply is connected to replace the battery. In this case, despite the fact that the coil's resistance is zero, the current flowing to the coil is not equivalent to the value sought by  $I = E/r$  but it is always a lower value. It is easy to confirm this by conducting experiments, and the reason is that, when an AC voltage is supplied to the coil, a resistance is produced which did not exist when DC current flows to the coil, and this serves to obstruct the current.

Therefore, as in circuit (3), even when the coil is directly connected to an AC power supply, the current flowing is not  $\infty$  (infinity) but a value which is determined by the presence or absence of the core, the number of coil turns and the voltage and frequency of the AC power supply.

Then why does the coil resist the AC current? When a current runs to a coil, magnetic flux is produced in proportion to the amount of that current. When the current is varied, a counter electromotive force is produced in the coil in a direction which obstructs the flux from varying. In other words, when the magnetic flux (or,

more precisely, current) is about to increase, this force tends to decrease and when it is about to decrease, this force tends to increase.

Since this electromotive force is generated in the opposite direction to the voltage supplied to the coil, it is known as a counter electromotive force. A counter electromotive force is produced in a coil because the magnetic flux varies in accordance with the variation in the current flowing in the coil. <sup>Note)</sup>

This phenomenon of an electromotive force being generated is known as the self-induction effect, and the degree of the strength that the coil has to obstruct the current variations is known as the coefficient of self-induction, or self-inductance, or simply, inductance. The greater the inductance of the coil, the greater the value of the counter electromotive force. Let's see what happens when a battery is connected to the coil in Fig. 2(1) and the voltage is varied.

If the current is now varied linearly (1 A/sec.) with respect to time as shown in Fig. 2(2) and if a counter electromotive force of 1 V has been generated in the coil, the inductance of the coil is defined as 1 Henry. (Symbol: H)

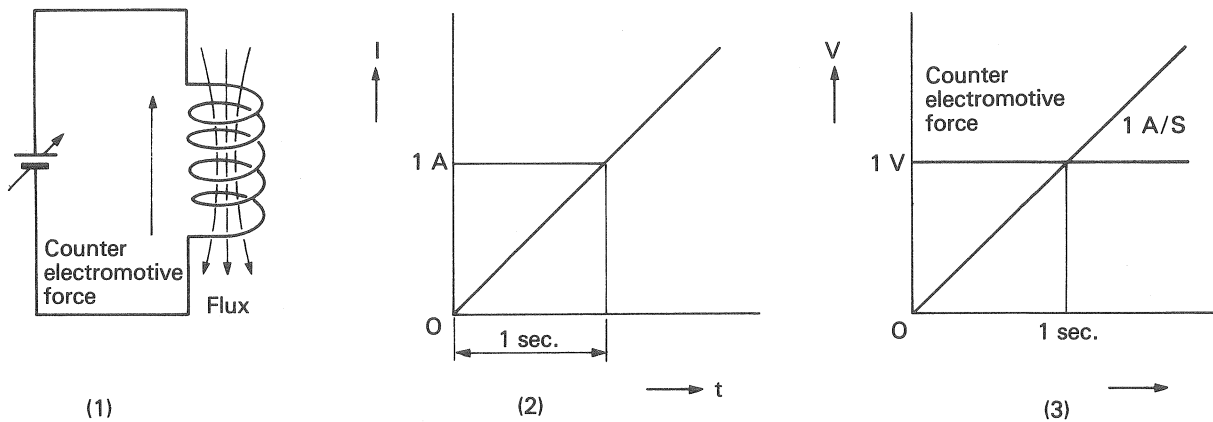


Fig. 2 Self-induction effect and counter electromotive force

Note) When a magnet is brought near coil L and then distanced as shown in Fig. 3, a voltage is induced in the coil during the period in which the magnet was moved. This is because the magnetic lines of force from the magnet pass through the coil and their strength varies.

Also, the current direction is reversed in accordance with the direction in which the magnet is moved, and this can be easily seen from the movements of a galvanometer pointer.

When, as shown in Fig. 4, coil L<sub>1</sub> with a galvanometer connected is brought near coil L<sub>2</sub> with a switch and battery connected and the switch is set to ON and OFF, a current flow in the galvanometer only during this period and its direction is reversed at the ON and OFF positions of the switch.

This phenomenon is known as electromagnetic induction.

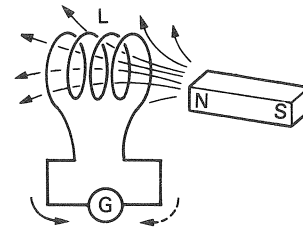


Fig. 3 Electromagnetic induction

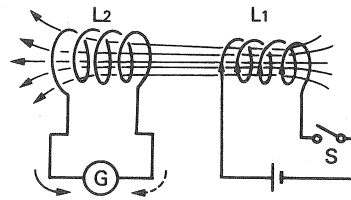


Fig. 4 Magnetic flux and current directions

**(2) Sine wave alternating current and coil reactance**

Next, let's see what happens when a sine wave alternating current is supplied to the coil.

As already mentioned, a counter electromotive force is produced in a coil in accordance with the current variations and this force increases in proportion to the speed of the current variations.

When a sine wave voltage is supplied to a coil, a sine wave

current runs to the coil and the counter electromotive force reaches its peak at the most rapid current variation. This means that this force is at its maximum when the current is zero, and at its minimum (actually, zero) when the current variation is zero. Therefore, as shown in Fig. 5, the relationship between the voltage and current is such that the current has a 90° delay with respect to the voltage.

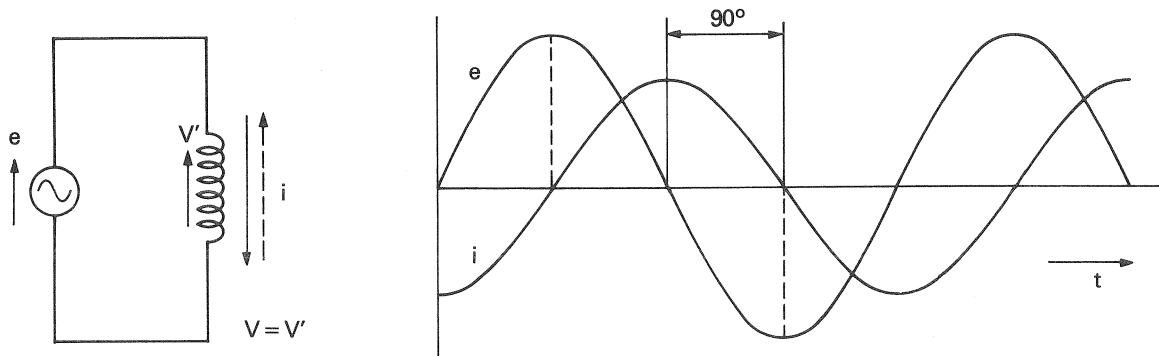


Fig. 5 Relationship between supplied voltage and coil current

Now, how does the current change in a coil of the same inductance when the frequency varies?

To make it easier to understand, the frequency is doubled.

Fig. 6 shows the sine wave AC voltage and current with the same voltage and a frequency ratio of 1:2.

Since the frequency is double, the current variation rate will be double if the current remains the same.

Therefore, double the counterelectromotive force is produced in the coil. However, since the supplied voltage is the same, this force cannot be double but must be the same value. In other words, the value of the current is half. This means that the resistance of the coil to the alternating current is double. From this fact, it is seen that the resistance of the coil to the alternating current is proportionate to the frequency. It is also proportionate to the inductance since the greater the inductance, the greater the counterelectromotive force.

The resistance of the coil to the alternating current is known as reactance and it is expressed with the symbol  $X_L$ .

Its unit is the ohm, just like with resistance.

The reactance of a coil can be expressed by the following formula:

$$X_L = 2\pi fL \quad (X_L: \Omega; f: \text{Hz}; L: \text{H})$$

This is an extremely important formula and is most basic when calculating the values in an AC circuit.

In the circuit shown in Fig. 5, the current can be determined from the following formula in the same way as Ohm's law.

$$I = \frac{V}{X_L} = \frac{V}{2\pi fL}$$

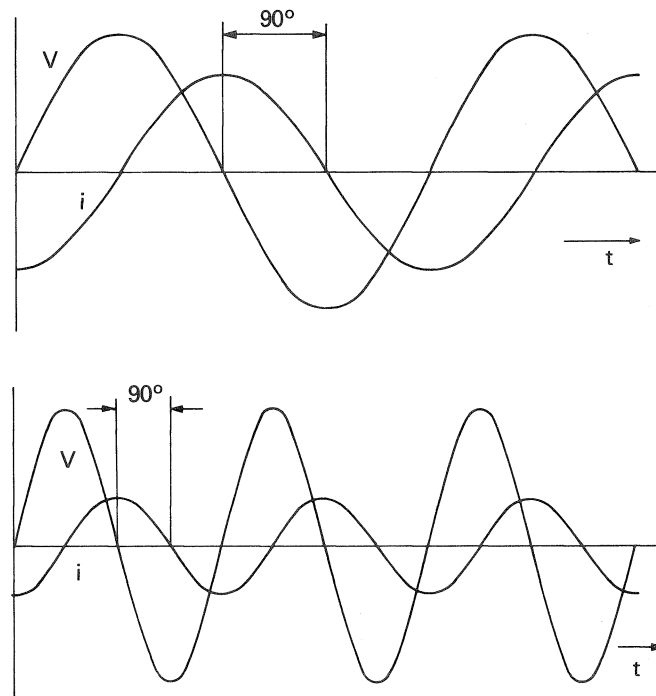


Fig. 6 Voltage, current with 1:2 frequency ratio

## 2. Capacitors

### (1) Properties of capacitors

There are many types of capacitors but in principle they can be considered as configurations of a pair of facing metal plates as shown in Fig. 7. The two conducting metal surfaces are separated by a dielectric (or insulator) and so it is obvious that no current flows through even when a battery is connected to both ends of a capacitor. Nevertheless, when an ammeter is inserted between the battery and capacitor and the switch is turned on, it is seen that the ammeter pointer deflects at that instant. (Refer to Fig. 8.)

This means that a current flowed momentarily though the flow does not continue. Why does a current flow even momentarily in a capacitor where no current is supposed to flow?

When a battery is connected to the two electrodes of a capacitor, a positive charge and negative charge appear at the electrodes. This charge is supplied from the battery and it is the movement of this charge (in other words, current) that has made the ammeter pointer deflect.

Let's now disconnect the battery which has been connected to the capacitor. The charge is not released but retained. In other words, it is stored in the capacitor.

Just as an automobile's fuel tank has a capacity, so a capacitor has capacitance. The amount of charge which is transferred from the battery (this charge is measured in coulombs <sup>Note</sup>) is equivalent to the amount of charge stored in the capacitor and its value is determined by the capacitance of the capacitor and the voltage applied to the capacitor. If the capacitance is made  $C$ , the applied voltage  $V$  and the amount of stored charge  $Q$ , then  $Q$  is proportionate to  $C$  and  $V$  and it can be determined by the following formula:

$$Q = C \times V \text{ so that } C = Q/V$$

The capacitance of a capacitor is expressed in farads (symbol F) and 1 farad is defined as the capacitance of a capacitor in which a charge of 1 coulomb produces a change of 1 volt in the potential difference between its terminals.

Since 1 farad is an extremely high quantity, capacitance is usually expressed in microfarads ( $\mu\text{F}$ ), one-millionth of a farad and picofarads (pF), one trillionth of a farad.

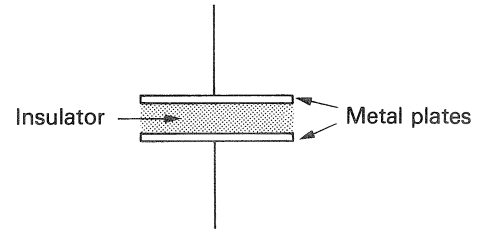


Fig. 7 Capacitor

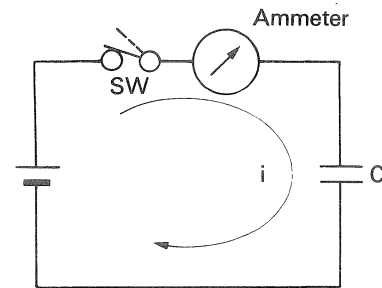


Fig. 8 Charging

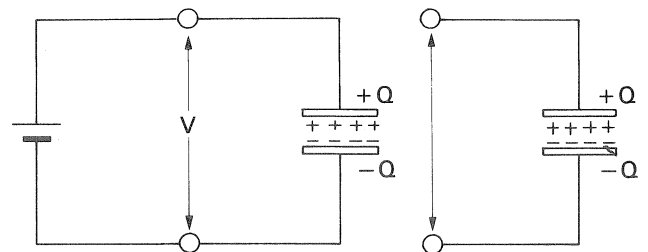


Fig. 9 Storage of charges

Note) A coulomb is an MKS unit of electricity, denoting the quantity of electricity which passes any point in an electric circuit in 1 second when the current is maintained constant at 1 ampere.

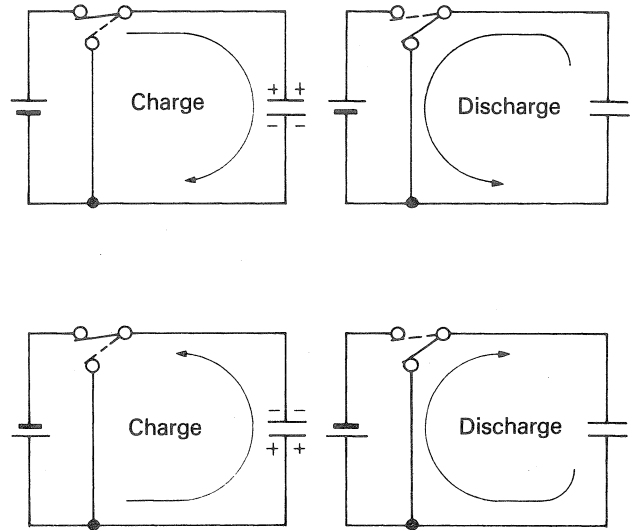
**(2) Sine wave alternating current and capacitor reactance**

As we have already mentioned, a capacitor is made up of two metal surfaces separated by a dielectric (insulator). Therefore, no current runs through it. However, a capacitor is characterized by the charge and discharge effect and so, as shown in Fig. 10, when a battery is connected across the two ends of a capacitor, then shorted and then re-connected over and over again, the capacitor repeatedly charges and discharges.

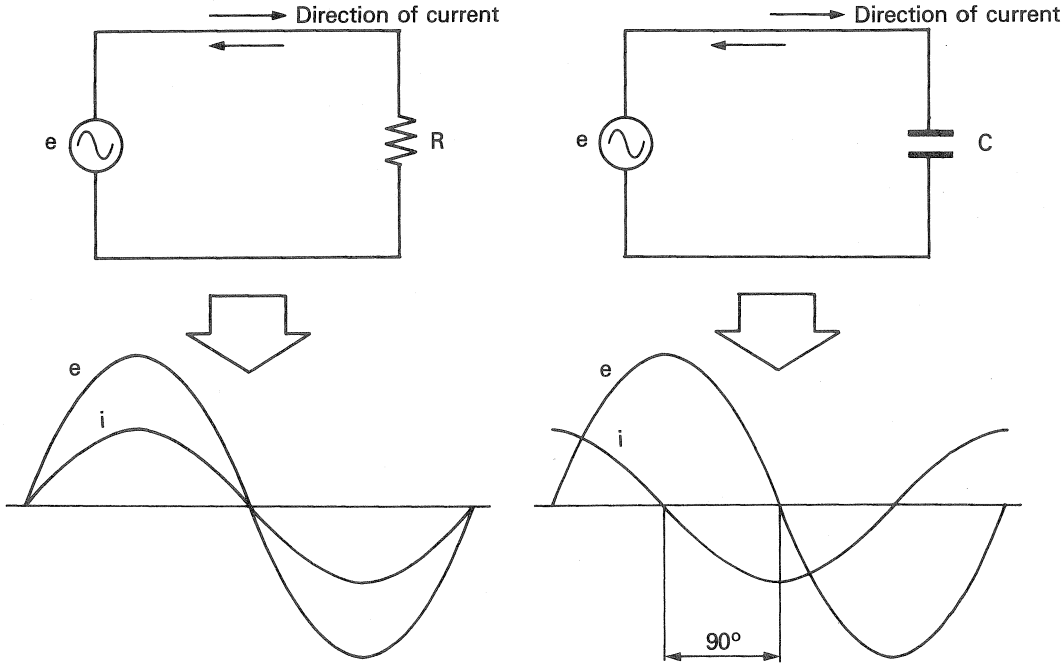
If a sine wave AC voltage is supplied instead of the connections based on a battery and switch, the capacitor repeatedly charges and discharges.

This means that an AC current is flowing. (Alternating current is a flow of electricity which reaches maximum in one direction, decreases to zero, then reverses itself and reaches maximum in the opposite direction continuously.)

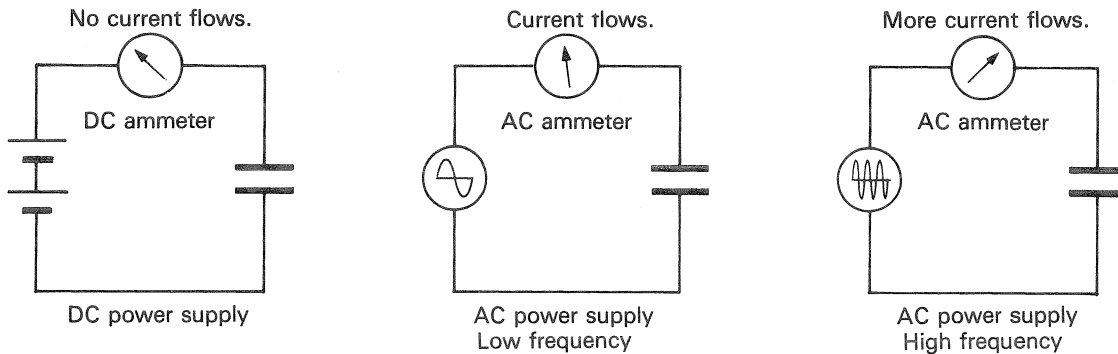
Fig. 10 shows this in a way which is easy to understand.



**Fig. 10 Charge and discharge effect of capacitors**



**Fig. 11 Relationship between voltage and current**



**Fig. 12 Frequency and current**

The important thing to remember is that the relationship between the current and the voltage supplied to a capacitor is different from that with a resistance in that there is a constant phase difference. The current flowing in a capacitor is 90° ahead of the supplied voltage <sup>Note)</sup>. This too is a very important fact in understanding electronic circuits.

Furthermore, the resistance of a capacitor equivalent to the resistance of a resistor is known as reactance. The unit is the ohm, as with resistance. Reactance is inversely proportional to the capacitance of the capacitor and to the frequency of the supplied voltage, and it can be determined from the following formula:

$$X_c = 1/2\pi fC \text{ (} X_c: \Omega; f: \text{Hz}; C: \text{F)}$$

Therefore, the current flowing to the capacitor when voltage V (V) is applied can be determined from:

$$I_c = \frac{V}{X_c} = \frac{V}{1/2\pi fC \times V} \text{ (A)}$$

Note) Relationship between supplied voltage and current flowing to a capacitor

In the circuit shown in Fig. 13, the voltage drops due to the presence of resistance “r” when the switch is turned on and so charging is not completed in an instant but takes a certain period of time. At this time, the current entering the capacitor and the voltage at both ends are as per Figs. 13(2) 1) and 2).

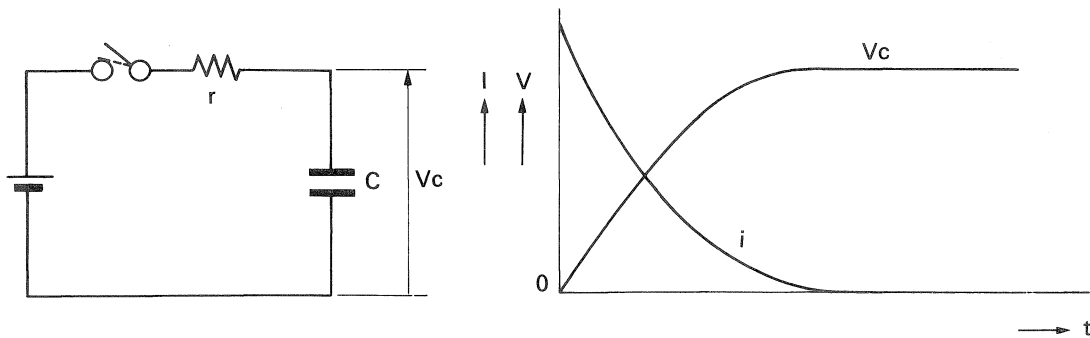


Fig. 13 Charging current & voltage

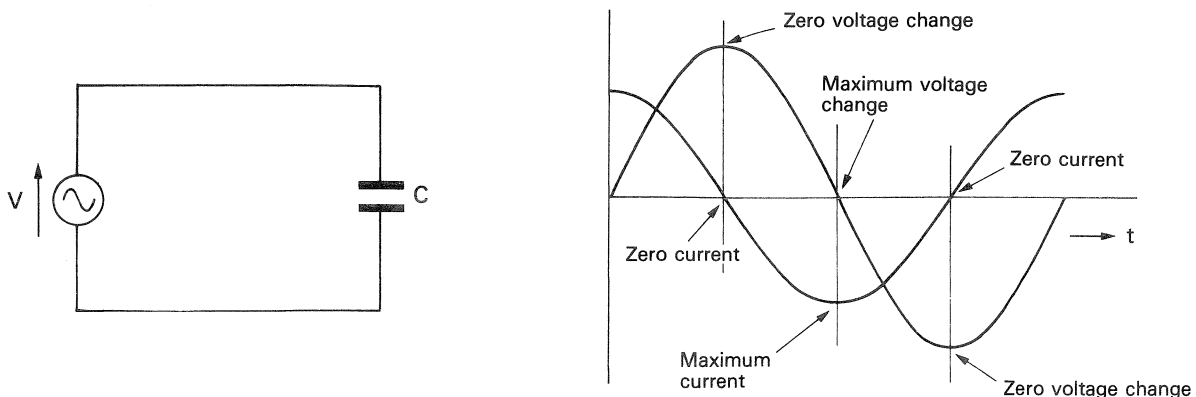


Fig. 14 Relation between sine wave voltage & current

The relationship between the voltage and current is such that the current reaches its maximum when the change in the voltage is at its peak while it decreases as the voltage change slackens, finally to arrive at zero.

The same thing happens when a sine wave AC power source is connected instead of the battery. The current reaches its maximum when the voltage change peaks at 0 (V) and it then reaches zero at the positive and negative peaks where the voltage change is at the minimum (zero). Therefore, the voltage and current waveforms can be expressed as those shown in Fig. 14.

### 3. Opposite nature of coils and capacitors

As you have already known through the explanations above, coils and capacitors have an exactly opposite nature.

The reactance of a coil is proportionate to the frequency while that of a capacitor is inversely proportionate.

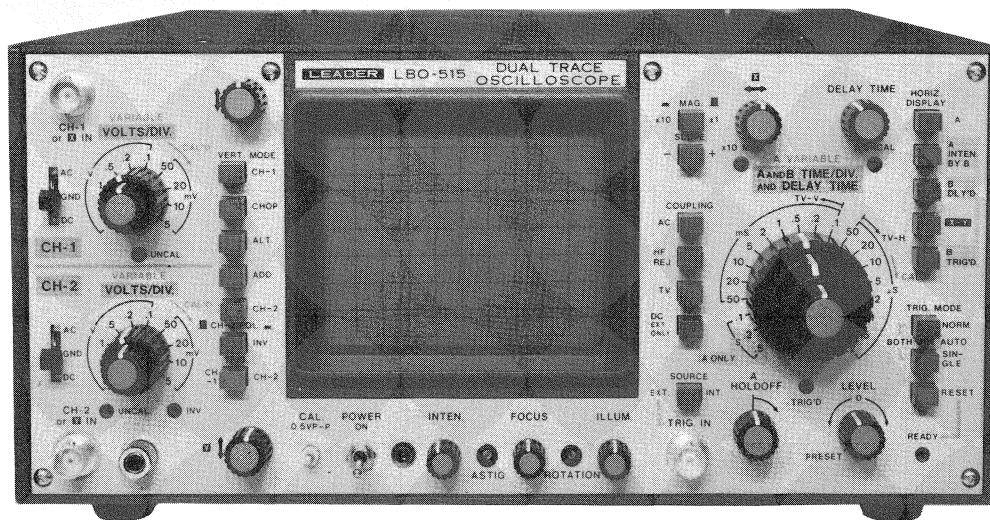
Also, current flowing in a coil is delayed by 90° to the voltage applied while that flowing in a capacitor is advanced by 90°.

Therefore, very interesting phenomena occur when combining a coil or capacitor with a resistor, or coil and capacitor together.

In the next issue we will study these phenomena.

# Measuring Instrument

## Oscilloscopes (2)



In the last issue of Tuning Fork, we looked into the principles and functions of oscilloscopes. In this issue we take a look at actual oscilloscope operation, waveforms and measurements using waveforms.

### 1. Precautions for Use and Measurement Preparations

The knobs and switches on an oscilloscope and its function will differ in accordance with the model and manufacturer. It is therefore necessary to read through the operating instructions before proceeding with operation. General hints are given below.

#### 1. Check the line voltage

There is no problem if the oscilloscope has been procured locally but care with the line voltage must be taken with an imported model. If the incorrect voltage is used, the oscilloscope may not be able to perform to the best of its ability and its service life may be shortened.

#### 2. Do not turn up the brightness too far

If the brightness of the CRT is turned up too much, the intensity volume control and the fluorescent (coated) screen may be burned, the light-emitting efficiency of the phosphor may be impaired and the brightness on the CRT's coated surface may become uneven. The same symptoms are apparent when a stationary waveform is traced for a long period of time.

Table 1 Standard oscilloscope voltages and usable voltage range

Standard voltage	Usable voltage range
100 V	90 V—110 V
117 V	106 V—128 V
217 V	196 V—238 V
234 V	211 V—257 V

**3. Do not apply excessively high tension input signals**

The same precaution can be given for any type of meter or instrument. To avoid excessive input, the measuring range should be stepped down from the highest until the wave amplitude can easily be observed appropriately.

**4. Install the oscilloscope in a well-ventilated location**

Although the main circuits are being transistorized, the CRT is still a vacuum tube where thermions are emitted by a heater and a great deal of heat is generated. It is therefore essential that the oscilloscope be installed in a location where the heat can dissipate freely without adversely affecting other parts.

**5. Allow the oscilloscope to warm up properly**

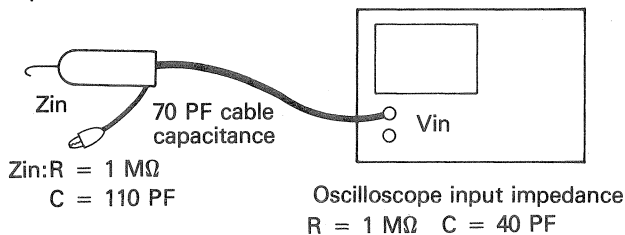
An oscilloscope should be allowed to warm up for at least 30 minutes so that its circuits will be operating stably during use.

**2. Probes**

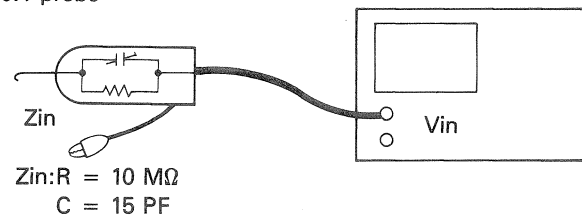
A probe which functions as a load is used to reduce the effect of the measuring equipment on the circuit under test during waveform observation, to prevent voltage induction on the measuring leads from the external source and waveform distortion and to attenuate high voltage accurately to expand the measurement range.

Probes generally feature 1:1 and 10:1 input voltage/output voltage attenuation. Since a 1:1 probe has a low input impedance, it is used only when the impedance of the circuit under test is low and the signal level and frequency are low. With the 10:1 probe, phase compensation is required since the cable has capacitance. Many oscilloscopes have a test terminal where a 1 kHz square wave can be fed out and so the compensation can be made while the waveform is monitored on the oscilloscope with the probe.

**1:1 probe**

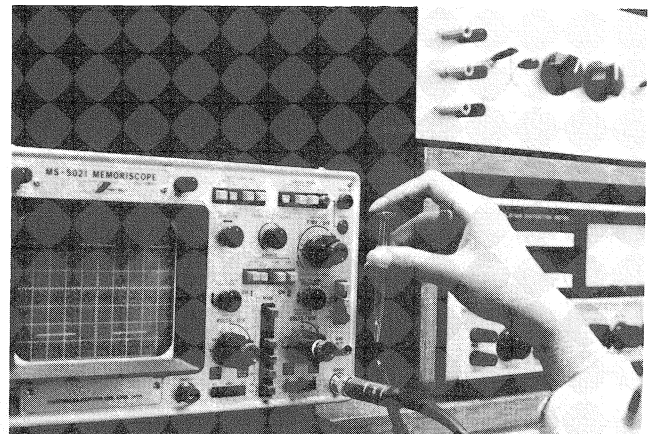


**10:1 probe**



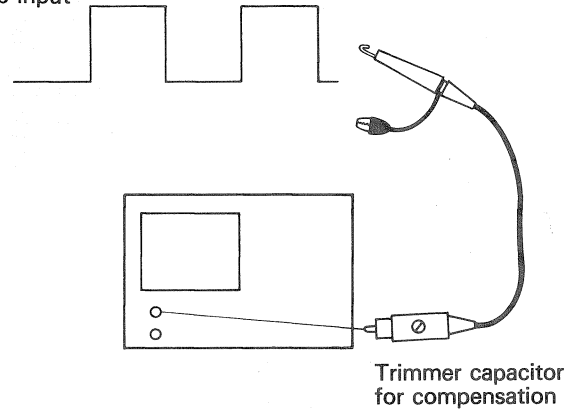
**Fig. 1 Input impedance with probe**

**Aligning the probe phase**

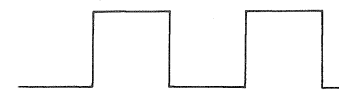


**Photo 2** Trimmer

1 kHz, 10 Vp-p input



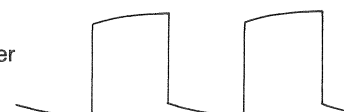
Trimmer capacitor adjusted correctly



Capacitance of trimmer capacitor is too high.



Capacitance of trimmer capacitor is too low.



**Fig. 2**



## 2. Measurements

### 1. Voltage measurements

#### 1-1. DC voltage measurements

Measurement is performed with the oscilloscope used as a DC voltmeter as follows.

- (1) The reference line is set to a position on the scale where the signal can be measured easily.
- (2) The input function selector is set to the DC range.
- (3) The voltage being measured is applied to the input terminal and the movement of the potential level is observed. If the movement is upward, the voltage is “+” and if downward, the voltage is “-”. The voltage is calculated from formula (1).

$$\text{Voltage (V)} = \text{Selected VOLTS/DIV} \times \text{level reading of input signal} \dots (1)$$

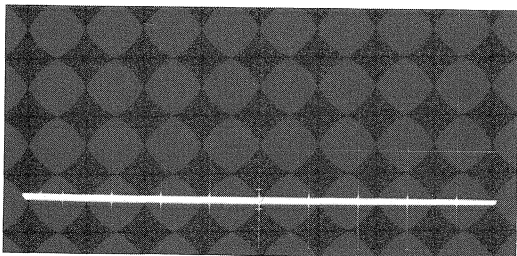
If a probe with an attenuator is used, the value in the above formula is multiplied by the reciprocal of the probe's attenuation.

#### 1-2. AC voltage measurements

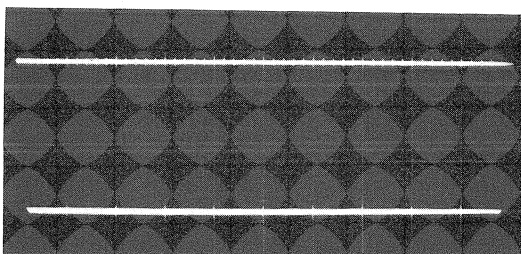
The procedure is the same as that for the DC voltage measurement except that the input function selector is set to the AC range.

Care must be taken that the observed value is V (peak-to-peak). When an RMS value is required, only a sine wave value can be calculated with formula (2).

$$\text{RMS value (V}_{\text{rms}}) = \frac{\text{Peak-to-peak value (V}_{\text{p-p}})}{2\sqrt{2}} \dots (2)$$



Voltage before measurement (0 V position)



↑  
DC Voltage  
V(p-p)  
↓

DC voltage applied to the input

Photo 3

To observe DC which has AC components, the input function selector switch should be set to the DC position for measurement inclusive of the DC component while at the AC position, measurement is possible without the DC component.

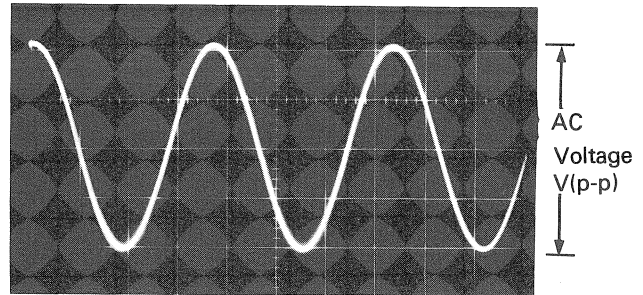


Photo 4

### 2. Frequency and phase

#### 2-1. Time measurement method

In almost all oscilloscopes, the horizontal sweep time is calibrated accurately, so it is possible to find out the signal period by measuring the horizontal distance of waves appearing on the screen.

- (1) The signal to be measured is fed to the input terminal, and the Time Base Control is adjusted so that the distance between the two points on the signal wave being measured is set appropriate for easy measurement. The time axis control is now set to “CALIBRATED”. The vertical axis is set so that the amplitude of the waveform can be observed easily.
- (2) The interval between certain points is measured using the scale on the screen, and this distance is multiplied by the selected TIME/DIV value.
- (3) When using a horizontal magnifier, its reciprocal is multiplied. The time between the two points can now be calculated with formula (3).

$$\text{Time} = \frac{\text{TIME/DIV} \times \text{width}}{\text{horizontal magnification}} \dots (3)$$

#### 2-2. Frequency counting

The following methods are available for ordinary frequency counting.

##### (1) Period-based counting

Calculation is possible using the above-mentioned time measurement method. Since a frequency is the reciprocal of a period, it is possible to measure the time by the above method and then determine the frequency from formula (4).

$$\text{Frequency (Hz)} = 1/\text{period (sec)} \dots (4)$$

**(2) Frequency counting in horizontal sweep time**

The frequency can be known by counting the waves on the screen and dividing them by the sweep time. It is quite a common method. Measurement is made with the following procedure.

- (a) The sweep time control is set to "CALIBRATED"
- (b) The image is stabilized and a few waves are formed.
- (c) The distance covered by a certain number of waves is measured.
- (d) The frequency is calculated from formula (5).

$$\text{Frequency} = \frac{\text{Number of waves}}{\text{distance} \times \text{TIME/DIV}} \dots\dots\dots (5)$$

With this method it is possible to reduce the error, compared with method (1), when there are many waves on the screen and the error can be minimized down to that of the sweep time. Conversely, when there are fewer waves, the error increases in the places below the decimal point.

Another way to measure a frequency is to use the oscilloscope as an X-Y scope and measure the frequency at a high accuracy by forming a Lissajous figure with a known signal. More details on Lissajous figures will be given later.

**2-3. Phase measurement**

There are two ways of measuring phase difference with an oscilloscope: one is to compare the phases of two signals with a dual-trace oscilloscope and the other is to produce a Lissajous figure by making an ordinary oscilloscope function as an X-Y scope.

**(1) Dual trace method**

The example given here is the observation of two sine waves of the same frequency with the different phase shift on a dual-trace oscilloscope. In this case, the wavelength of the signal with the advanced phase is made into 9 divisions with the TIME/DIV control. With this operation, 1 division is made 40° and so the difference in phase between the two waves is calculated in formula (6).

$$\text{Phase difference (deg)} = \text{Interval between two waves on horizontal axis} \times 40^\circ \dots\dots(6)$$

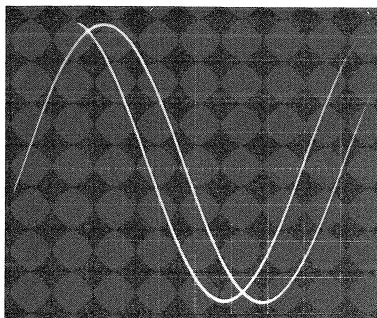


Photo 5

**(2) Measurement using Lissajous figures**

The horizontal axis of an oscilloscope is set to the external sweep, the signal to be measured is supplied to one axis and the reference signal is supplied to the other axis, then a Lissajous figure is produced on the screen, and the frequency and phase can be measured from the figure.

With a 90° phase difference between the X and Y signals, the ratio of the number of peaks rising from both axes is the ratio of the signal frequency to be measured to the reference frequency or its reciprocal.

Therefore, a frequency can be known by varying the reference frequency and observing the stationary Lissajous figure produced on the CRT screen.

To measure the phase angle, first the vertical gain is set to zero and then the horizontal beam line to the center (base line) using the vertical position control and the length of the beam line is read out (Xmm). Next, the gain is increased and an ellipse is formed. If the length between the points where the ellipse intersects the zero level line is "x" (mm), phase angle θ can be calculated from formula (7) and the circular function table.

$$\text{Phase difference: } \sin \theta = x/X \dots\dots(7)$$

When the phase difference is 90°, the Lissajous figure becomes a perfect circle but if it is not 90° or the signal is distorted, the circle distorts and an error results in the phase measurement.

Lissajous figures with 1:1 frequency ratio, and  $0^\circ$  and  $90^\circ$  phase difference

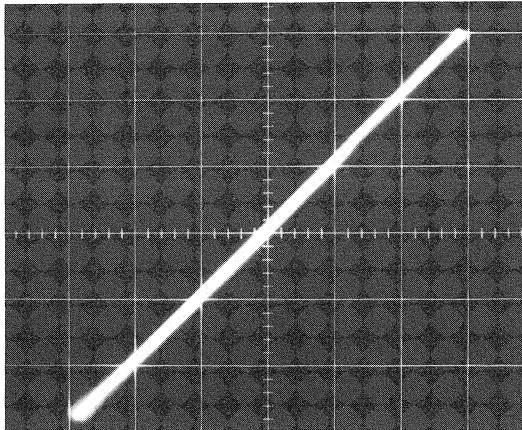


Photo 6  $0^\circ$  phase angle

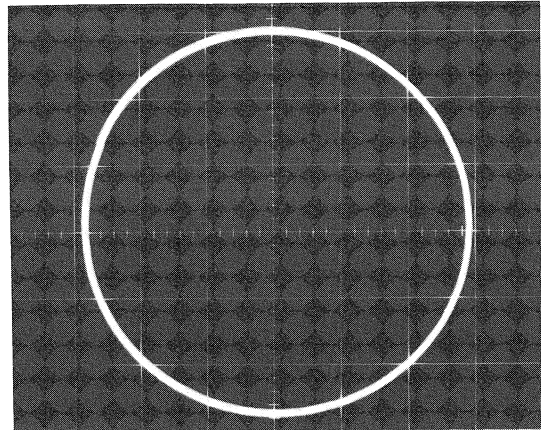


Photo 7  $90^\circ$  phase angle

Lissajous figures with 1:2 frequency ratio, and  $0^\circ$  and  $90^\circ$  phase difference

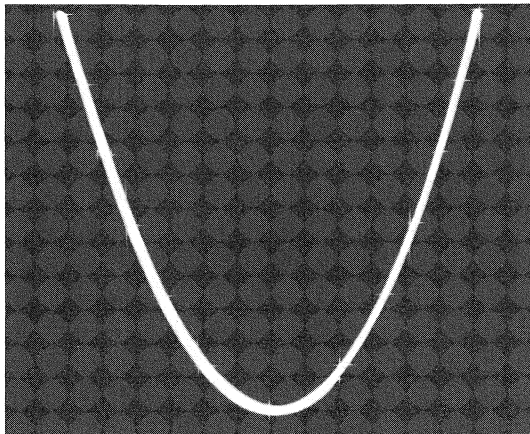


Photo 8  $0^\circ$  phase angle

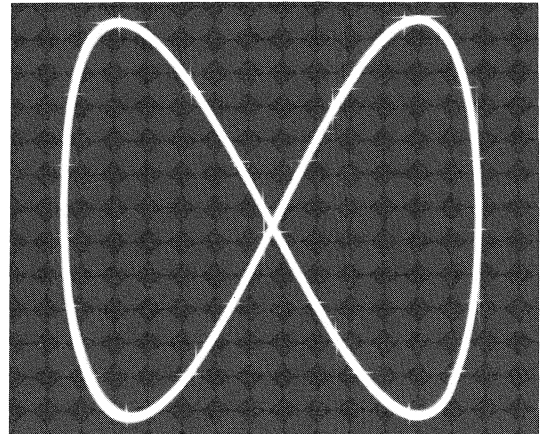


Photo 9  $90^\circ$  phase angle

Lissajous figures with 1:3 frequency ratio, and  $0^\circ$  and  $90^\circ$  phase difference

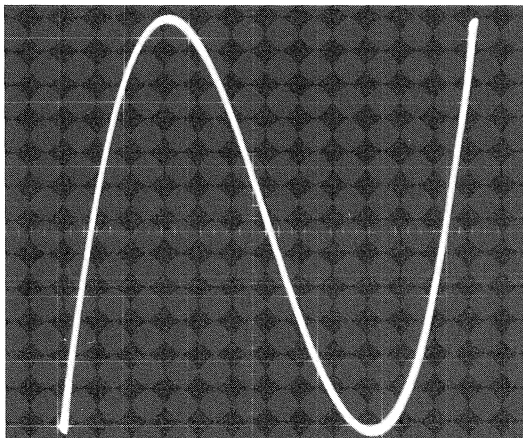


Photo 10  $0^\circ$  phase angle

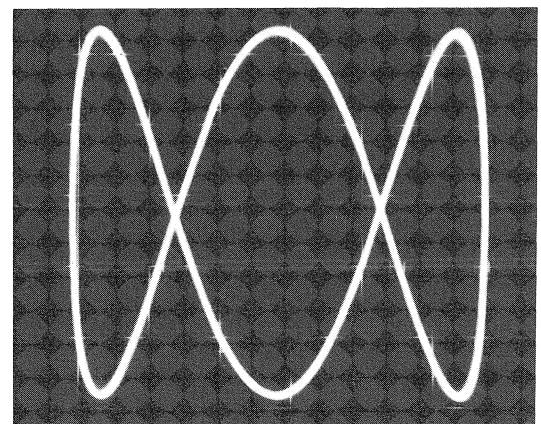


Photo 11  $90^\circ$  phase angle

### 3. Pulse wave measuring methods

In the One-Point Service section in Tuning Fork No. 4 we explained that square waves contain many different frequency components and so by feeding square waves into an amplifier and observing the output waveforms, it is possible to check the characteristics of the equalizer circuit, tone control circuit and filter circuit.

In the latest amplifiers more space is given in the catalogs to such dynamic characteristics as the slew rate and rise time than to the static characteristics. These are also measured using square waves. The latest digital circuit signals are all pulse signals. In this section we shall talk about pulse waveforms which are becoming popular in many fields.

#### 3-1. Pulse wave measuring methods

What's a pulse waveform?

##### (1) Detailed definition of a pulse waveform

An ideal pulse is characterized by its momentary uprise, unchanging high level and momentary downfall to the reference level. However, the pulse waveforms are usually distorted during transmission. Let us see some typical waveforms.

##### (2) Pulse waveform definitions

(a) Single pulses (see Fig. 4)

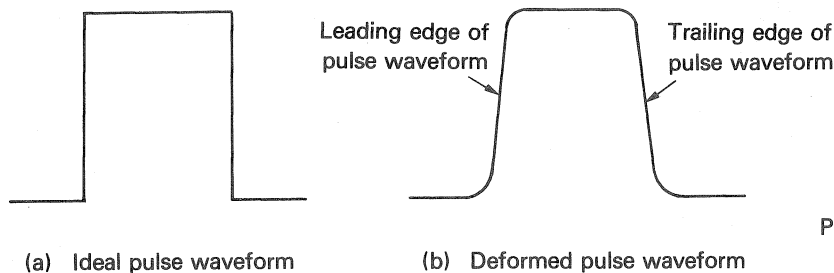


Fig. 3

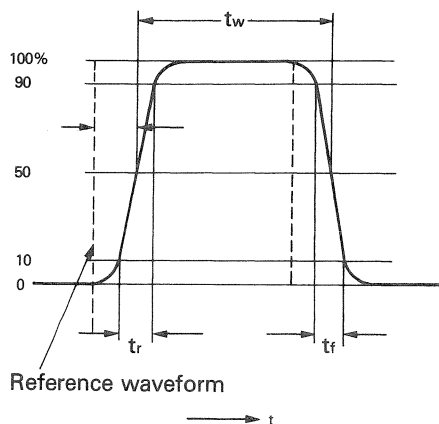


Fig. 4

##### 1. Rise time ( $t_r$ )

This is the time required for the leading edge of a pulse to rise from 10% to 90% of its final value.

##### 2. Fall time ( $t_f$ )

This is the length of time during which a pulse is decreasing from 90% to 10% of its maximum amplitude.

##### 3. Pulse width ( $t_w$ )

This is the time interval between the points at which the level of the leading and trailing edges become 50% of the peak pulse amplitude.

##### 4. Delay time ( $t_d$ )

This is the amount of time one signal output is behind another (input) measured at the points where both pulses' levels becomes 50% of their peak pulse amplitude.

(b) Repeat pulses (see Fig. 5)

##### 1. Repetition period ( $t_p$ )

This is measured at the point where the pulse amplitude is 50% of the peak.

##### 2. Characteristic frequency ( $f_{kHz}$ )

Reciprocal of pulse width "tw"

$$f_{kHz} = 1/t_w$$

##### 3. Repetition frequency ( $f_p$ )

Reciprocal of pulse period ( $t_p$ )

$$f_p = 1/t_p$$

##### 4. Pulse waveform distortion (see Fig. 6)

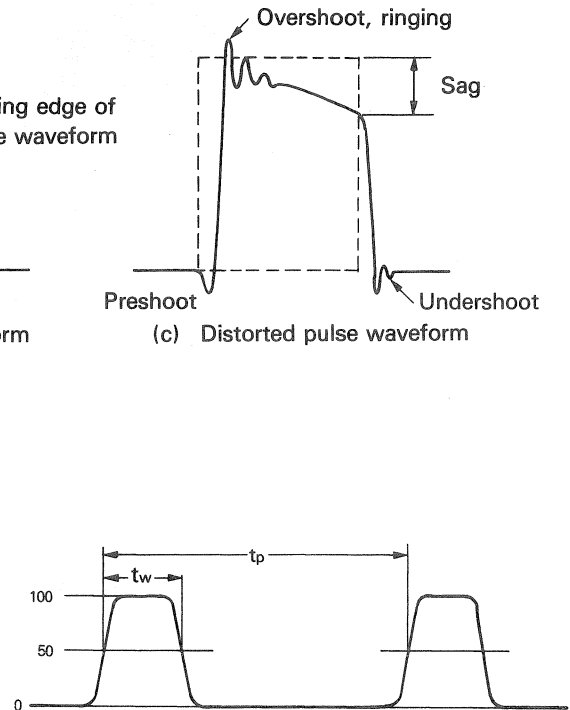


Fig. 5

Most pulse waveforms observed have an overshoot, sag and other forms of distortion. These forms of distortion are defined as the ratio of amplitude B of the distorted section to amplitude A of the ideal waveform (Fig. 6).

$$\text{Distortion} = B/A \times 100 (\%)$$

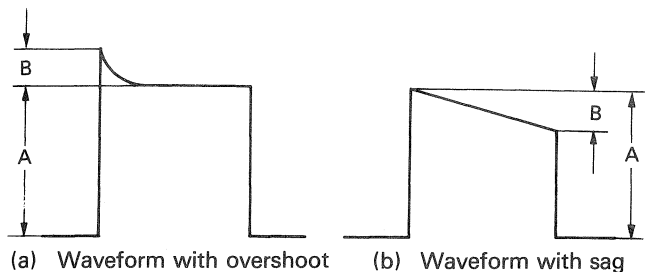


Fig. 6

### 3-2. Pulse waveform measuring methods

Since pulse waveforms are characterized by a much higher speed than ordinary waveforms, it is important to have in advance a firm grasp of the properties of the waveform being measured and to select the most appropriate operation. Let's now look at methods to measure the pulse waveforms defined in the previous section.

Since the changing speed of the pulse level is extremely high, the oscilloscope used for measuring the pulse waveforms must have a good frequency characteristic and a trigger signal is required for the sweep.

#### 1) Measuring rise time $t_r$ and fall time $t_f$

- a) The pulse's rising section is set to the center.
- b) The horizontal position control is set so that the vertical center line crosses the rising (falling) curve at a point 10% below the peak amplitude. Then the length between the point where the curve crosses the horizontal center line and the screen center ( $T_1$ ) is read out. (See Fig. 7)

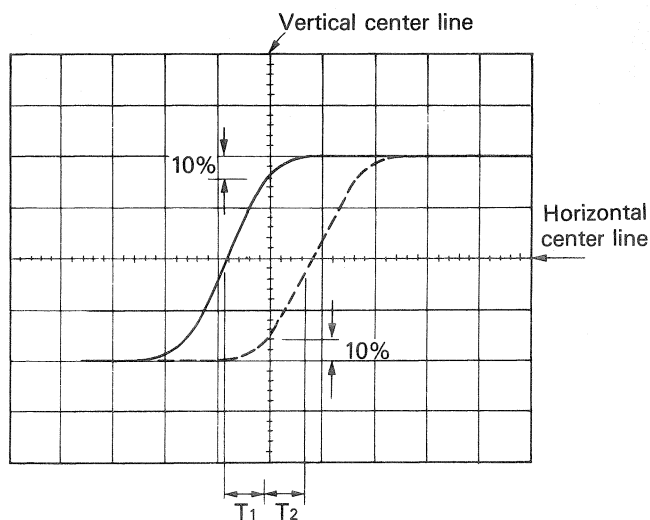


Fig. 7

- c) In the same way, the width between the 10% point and the center of the curve ( $T_2$ ) is read out.
- d) Substitute  $T_1$  and  $T_2$  in formula (3) and find the rise (fall) time.

When the rise (fall) time of the pulse being measured approaches the upper critical speed of the oscilloscope's vertical amplifier, the figure is affected by the rise time characteristics of the amplifier and an error results. Care must therefore be taken.

#### 2) Pulse width ( $t_w$ ) measurement

- a) The pulse wave is deflected for  $\pm 2$  or  $\pm 3$  divisions vertically at the center.
- b) As in Fig. 8, the pulse width between the points where the pulse waveform crosses the center horizontal line is read out and calculated with formula (3).

#### 3) Repetition period $t_p$ measurement

- a) Proceed in the same way with the " $t_w$ " measurement, and dual pulse waves are formed on the screen. Refer to Fig. 9.
- b) The width of " $t_p$ " is read out and the repetition period is calculated from formula (3).

The pulse wave measuring methods using an oscilloscope have now been outlined.

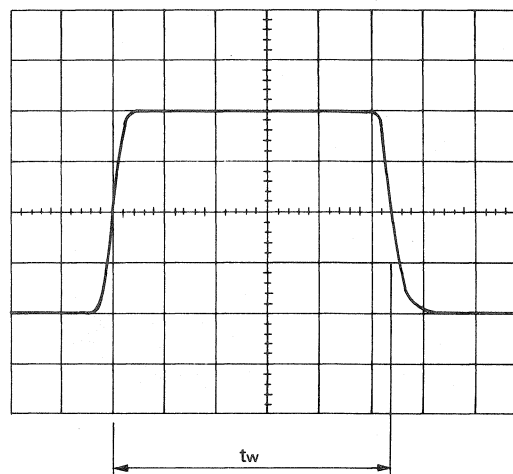


Fig. 8

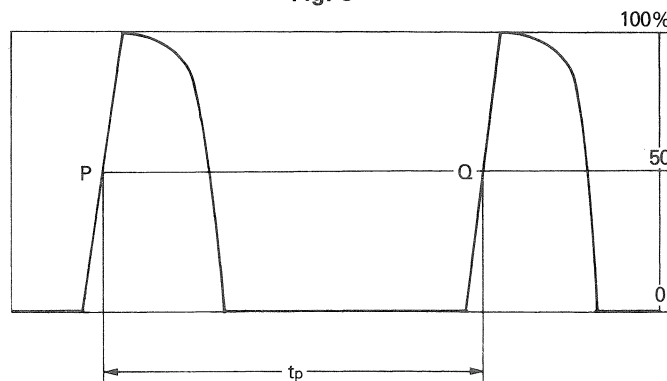


Fig. 9

---

# One Point Servicing Techniques

---

## Multi-Play Deck with PMS

---

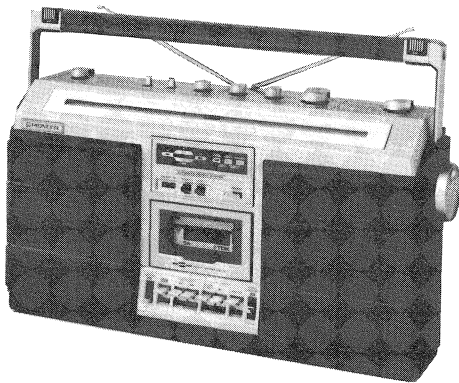
### 1. What's a multi-play deck?

Along with the improvements made in the motors, transporting mechanisms and other electronic parts and with the better quality of the accompanying tapes, the performance of hi-fi tape decks has now reached the level where there is very little difference between the wow/flutter and frequency response specifications in the products marketed by the various audio manufacturers.

On the other hand, demands placed on portable audio decks focus not only on their performance as recording and playback machines but also on a full complement of functions which are designed to give the customers, which comprise mainly women and children rather than out-and-out audiophiles, a great deal of fun.

Pioneer has been well aware of the above trends and it has developed a whole range of functions for its new series of radio cassette recorders and music centers by combining the Pioneer Music Select (PMS or Song Finder™) system that locates programs on the tape where music has been recorded and newly developed mechanisms, the company offers repeat program location and other multiple play functions.

Following are a description of the multiple play functions and the models in which they are used. Next come details of the mechanism operations and finally the PMS system is described.



SK-51

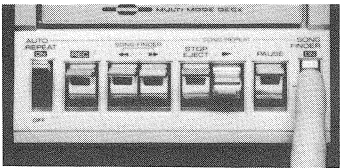
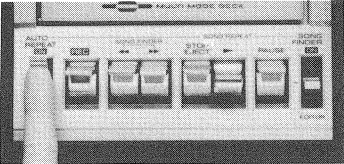
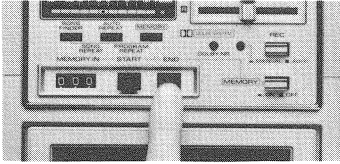
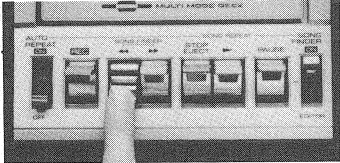
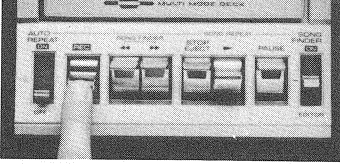
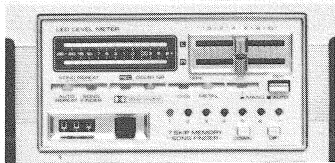
PMS built in cassette tape recorder



KH-8855

PMS (Song Finder™) built in 3-in-one music system.

## Listing of Functions

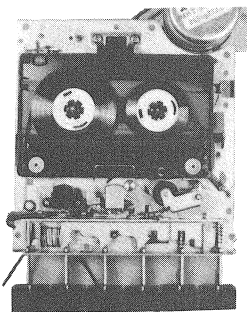
Function	What to push	Operation Switch Setting	Operation
1. One-song repeat	 <p style="text-align: center;">ONE-SONG REPEAT</p>	Auto Repeat SW: ON PMS (Song Finder) SW: ON MEMORY SW: OFF	This function allows one song which you like to listen to be repeated any number of times. Play — Stop (at the following blank space) — Rew — Stop (at the preceding blank) — Play.
2. Auto repeat	 <p style="text-align: center;">AUTO REPEAT</p>	Auto-Repeat SW: ON PMS SW: ON MEMORY SW: OFF	This function allows all the songs on one side of the tape to be played repeatedly for any number of times. Play — Stop (tape end) — Rew — Stop — (tape beginning) — Play.
3. Programmable repeat	 <p style="text-align: center;">PROGRAMMABLE REPEAT</p>	Auto-Repeat SW: ON MEMORY SW: ON Start Button: Set at the beginning of a song END button: Set at the end of a song PMS SW: OFF	This function allows you to repeatedly play back parts of the tape (parts of songs which you like) any number of times. Play — Stop (at the point where end button was set) — REW — Stop (at the point where start button was set) — Play.
4. Song finder (SK-95)	 <p style="text-align: center;">SONG FINDER</p>	Auto Repeat SW: OFF PMS SW: ON MEMORY SW: OFF	This lets you skip over unwanted programs and play your favorite ones. FF (or REW) — Set — Stop (at the blank) — PLAY.
5. One-touch recording	 <p style="text-align: center;">ONE-TOUCH RECORDING</p>		You don't have to use both hands to make on-the-spot recording; one finger is enough.
6. 7-Skip Song-finder			This feature has a built-in memory so you can program it to skip over up to seven songs automatically.

## List of Products with Multi-Play Deck

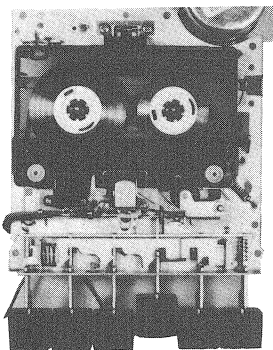
Model	One-song repeat	Auto repeat	Program-mable repeat	Song finder	One-touch recording	7-Skip Song-finder
Radio cassette recorders						
SK-51	○	○	○	○	○	
SK-61	○	○		○	○	
SK-71	○	○	○	○	○	
SK-95	○	○		○	○	○
SK-31	○	○	○	○	○	
SK-21		○		○	○	
Music systems						
KH-4455/454 (4433/KU)		○		○	○	
KH-5577/565 (5566/KU)		○		○	○	
KH-8811/818 (8833/KU)		○		○	○	
KH-8855/858		○		○	○	

## 2. Principle of multi-play deck mechanism operation

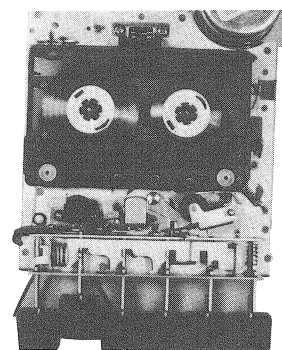
### Conventional mechanism



STOP  
Photo 1

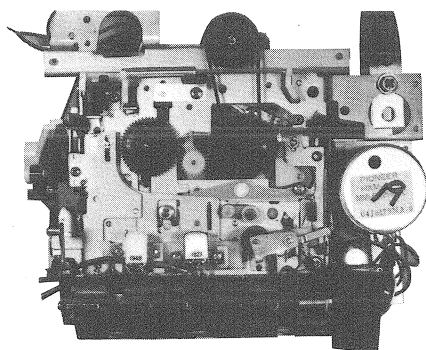


PLAY  
Photo 3

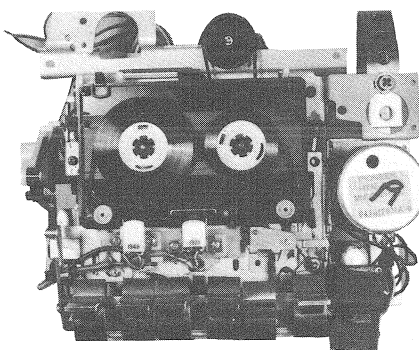


FF/REW  
Photo 5

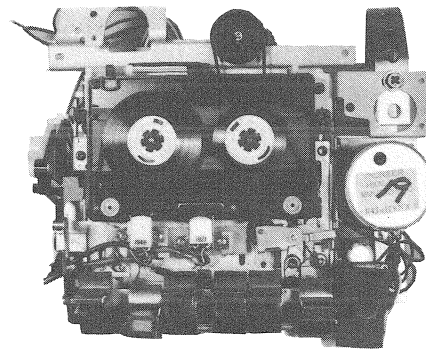
### Multi-play mechanism



STOP  
Photo 2



PLAY  
Photo 4



FF/REW  
Photo 6



If you have studied the photos, you will no doubt have noticed that the big difference between the conventional mechanism and the multi-play mechanism lies in the fact that the tape and the magnetic head are not completely separate in the stop, FF (fast forward) and REW (rewind) modes but actually touch each other, although very slightly. By maintaining this positional relationship between the head and the tape, it is possible to discriminate between the recorded and unrecorded positions on the tape even at positions other than play using the PMS system, which will be detailed later.

2-1. Let's now see how the head base (the erase and recording play back head are incorporated into the unit on a base) moves from the position in Photo 4 (pinch roller is separated) to the position in Photo 6 (play mode). At the position in Photo 5 gear 1 is hooked by the solenoid lever. This gear is characterized by 3 design points, as can be seen in Photo 7.

3. By installing a part with a pawl behind the gear, it is possible to configure a hook mechanism and electrically control the ON/OFF locking with a solenoid.

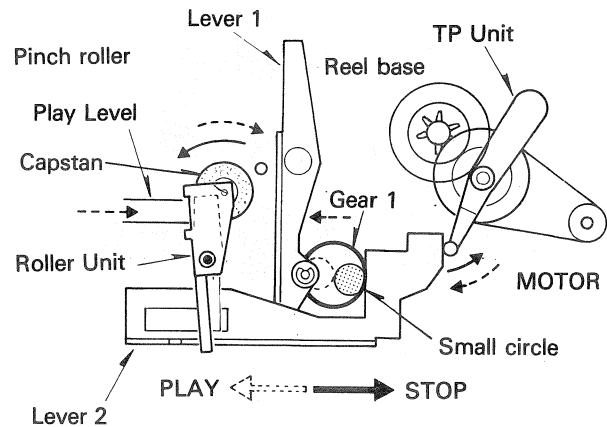
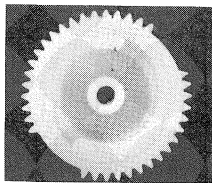


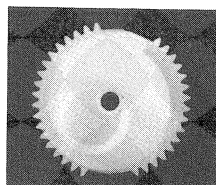
Fig. 2

Sections without teeth



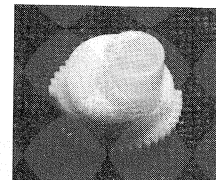
Gear  
(a)

Parts where solenoid driver is hooked



(b)

Small circle (cam)



(c)

Photo 7

1. The gear is toothed around its circumference except in two places opposite each other, and it is possible to stop the power transmitted from an external source at 180° (half rotation).
2. A cam mechanism is located at the rear and the force provided by the gear rotation is converted into vertical motion.

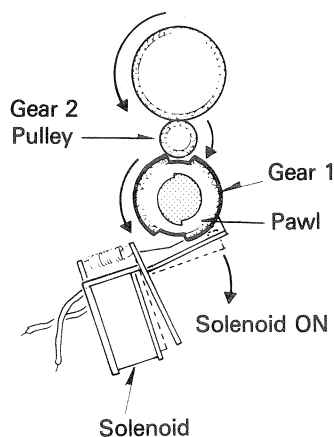


Fig. 1

Let us now continue describing the operation. At the position where the gear is hooked by the solenoid lever, the related position with gear 2 (pulley) is such that gear 2 now faces the section of gear 1 without teeth. This means that by the rotation of the motor, the rotations of gear 2 (pulley) are not transmitted to gear 1.

Take a look now at the positions of lever 1 and lever 2. The head base is pushed down by lever 1 at the position of gear 1's small circle. As a result, the pinch roller is separated from the capstan shaft.

Furthermore, lever 2 is pushed up (same position) by the position of the gear 1's small circle. This causes the end of the TP (tension pulley) unit's lever to be raised and so the TP unit is rewound and isolated from the reel base. Because of the two points above, the tape does not travel and the reel is not rewound.

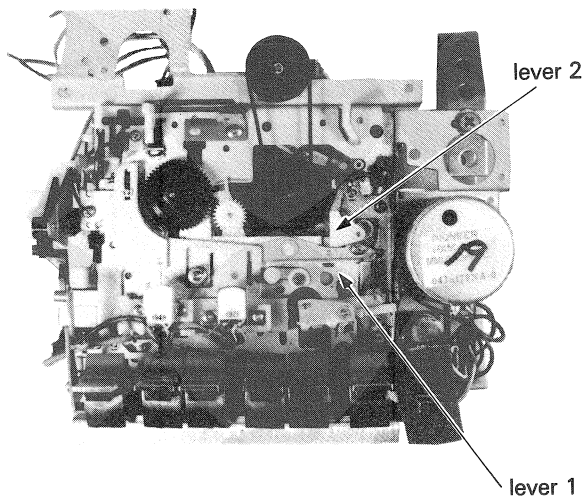


Photo 8 Head base down position  
STOP F.F, REW

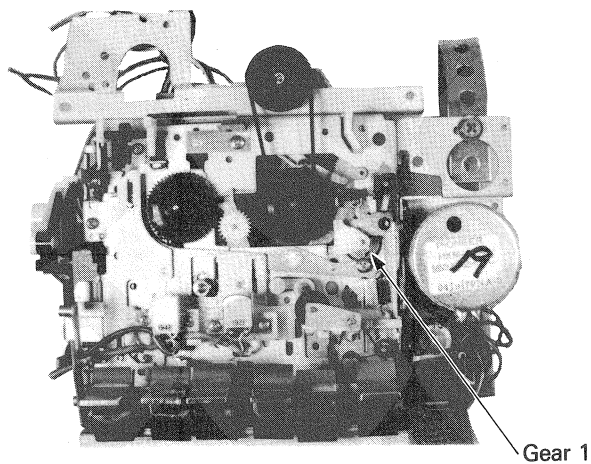


Photo 9 Head base up position  
PLAY/REC-PLAY

## 2-2. Operations during play

Let's think what happens when the solenoid lever works and it is disengaged from gear 1.

When the solenoid lever is disengaged from gear 1, the small circle section (cam) rotates slightly to the right (when viewed from the front) by the force of lever 2's spring. When this happens, the teeth of gear 1 and gear 2 interlock and rotation starts. If attention is now paid to the position of the gear 1's small circle section (cam), the whole operation becomes easier to understand.

When gear 1 goes through a half rotation, the pawl which has hooked gear 1 and the parts of the pawl on the opposite side are hooked by the solenoid lever. Refer to Figs. 3. Just as with the STOP position, the part on gear 1 without teeth stands opposite gear 2 (pulley).

The position is that gear 1 has become fixed. The movements of lever 1 and lever 2 are totally reversed from the STOP position.

Lever 1 pulls up the head base and this makes the pinch roller adhere to the capstan. Lever 2 is also pulled down and the TP unit is contacted to the reel base. As a result, the take-up base starts to rotate. Under the above conditions, the tape travel and rewinding start. This state is shown in Photo 9 and Fig. 4 shows an engagement of the section in question.

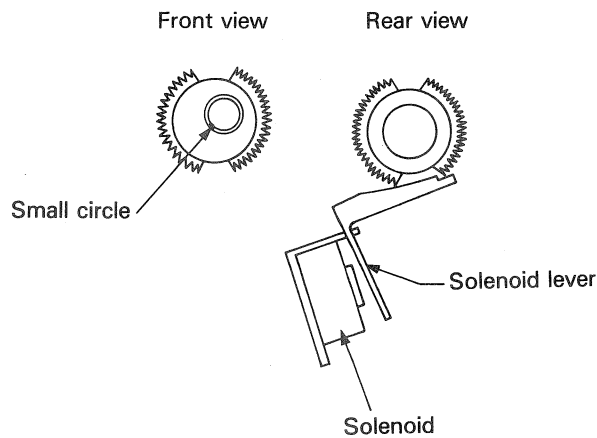


Fig. 3 Stop position

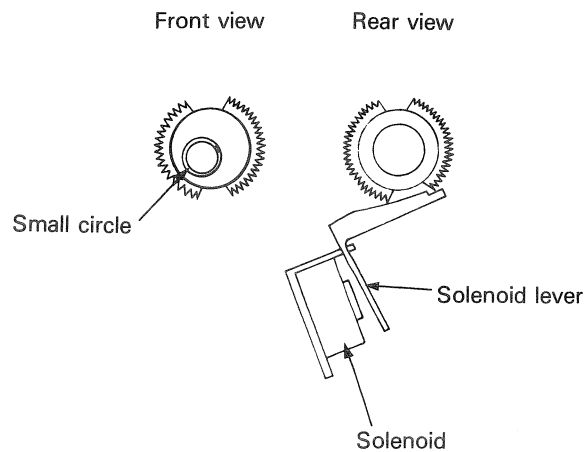


Fig. 4 Play position

### 2-3. Auto-stop operation

While the tape is traveling (play, FF or REW mode), the pawl (Fig. 5) coupled to the take-up reel base is always trying to rotate to the right (REW mode) or to the left (play, FF mode). Consequently, the pin (arrow marked) on the lever with the hole positioned between the pawl is depressed to the right or is drawn to the left. This lever is then joined to the stop lever.

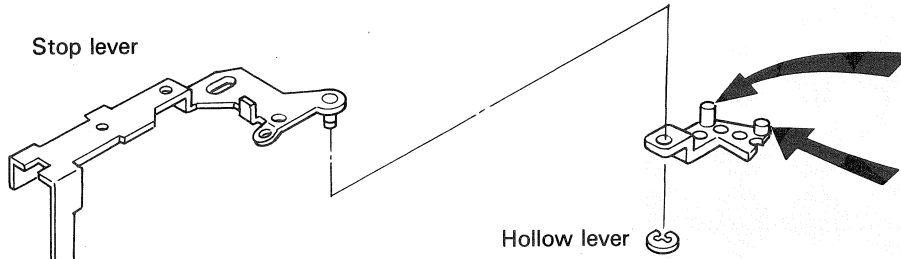
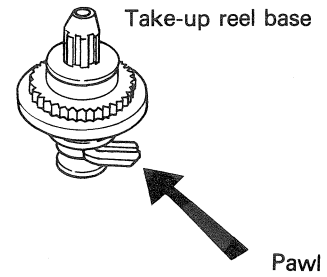


Fig. 5

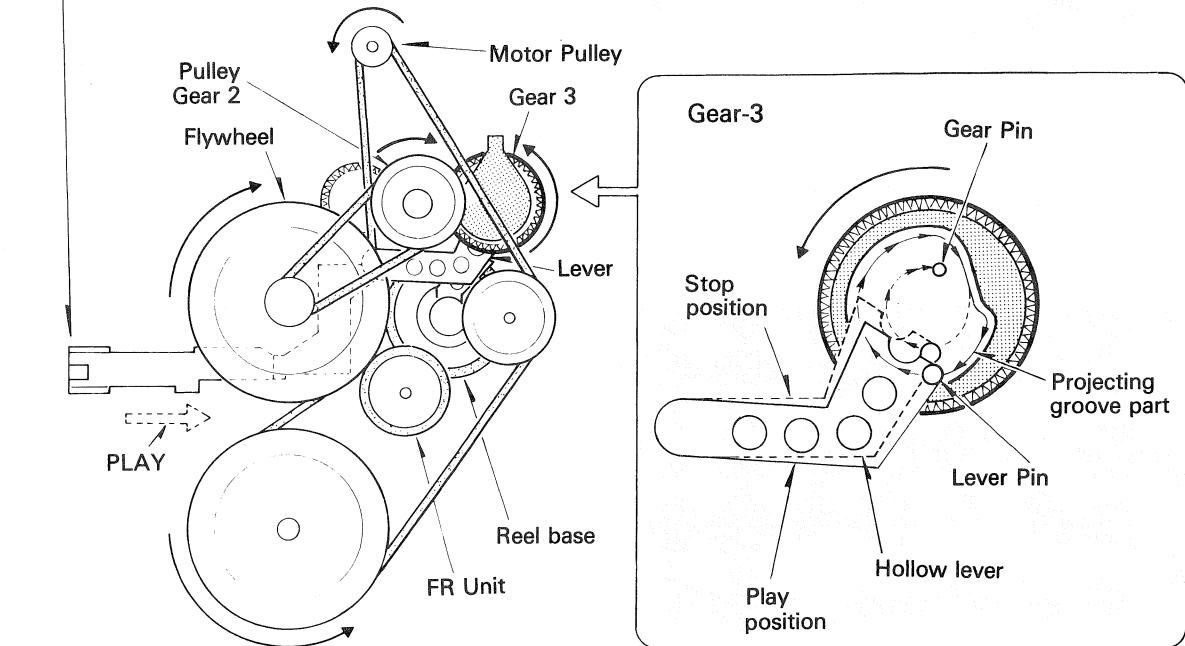


Fig. 6

Take a look now at the shape of gear 3 which is linked to gear 2 (pulley). Refer to Fig. 6 and Photo 10. Since the lever is pushed toward the right or left during tape travel, the pin (arrow in Fig. 6) at the end of the lever runs along the outer circumference of the indented part of gear 3 or along the outer circumference of the inside projecting part (egg-shaped).

The pin moves in accordance with the shape of gear 3's projecting or indented part edge. Therefore, it does not come into contact with the gear pin provided on gear 3 as it travels.

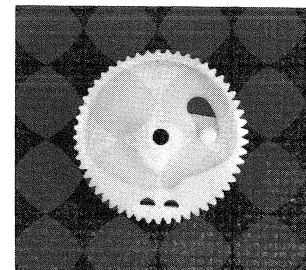


Photo 10

When the tape stops traveling, the take-up reel base stops and the pawl which is coupled to the base also stops simultaneously.

During this time gear 3 continues to rotate. The pin at the end of the lever is brought to the center by the shape of gear 3's projecting or indented part edges, and it stops. A pin is provided at the center traveling part of gear 3 and

We shall now explain in detail what happens until the solenoid lever is mechanically activated by the stop lever. Refer to Photos 11 and 12 and to Fig. 7.

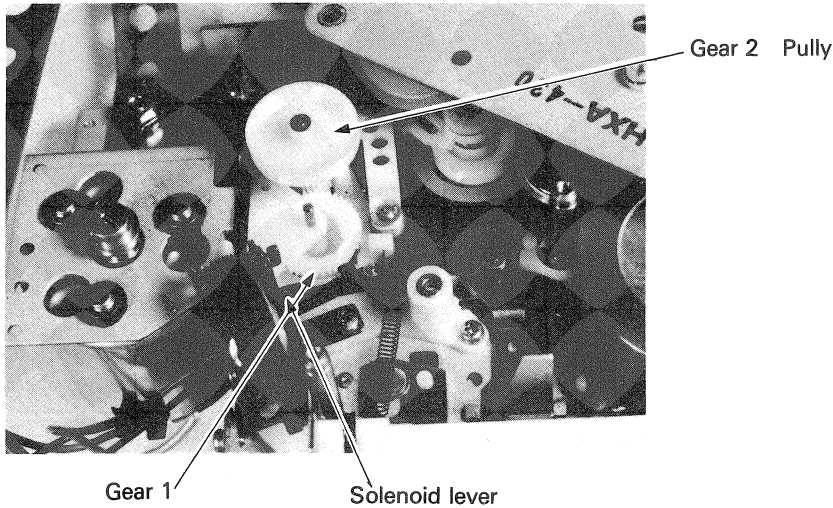


Photo 11

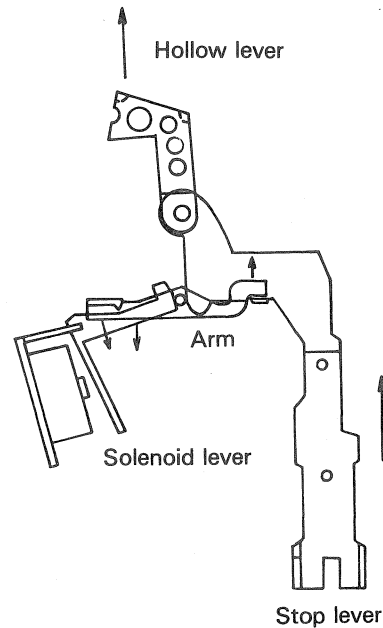


Fig. 7

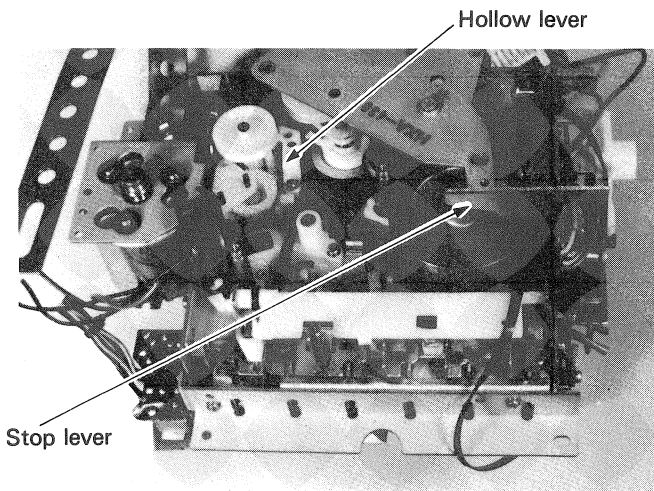


Photo 12

the pin at the end of the lever catches on it. Even after it is caught, gear 3 continues to rotate and so, as a result, the lever is raised and the stop lever connected to it is also raised.

When the movement of the stop lever disengages mechanically the solenoid lever, all the function buttons are also released.

The arm is coupled to lever 1 and it moves up or down.

The lever is coupled to the stop lever. When the stop lever is raised (same as depressing the stop button), the arm between the stopper lever and the solenoid lever operates as in Fig. 7. Operation is as per steps 1, 2 and 3 in Fig. 7. However, this arm's center is coupled to lever 1 on the rear and so it moves up and down in accordance with the movement of lever 1. This is why the arm releases the solenoid lever only during the play mode.

## 2-4. Operations of functions

We shall now describe the functions, based on the basic operations detailed in 2-1, 2-2 and 2-3.

This multi-play deck is used in many models. The electrical circuitry differs slightly in each model, and the switch numbers are also different for each model.

The following description is based on model SK-51 and the switch numbers are therefore based on this model.

Try to imagine that the position of the head base is like that shown in Photo 2 when the cassette has been loaded.

## 2. Play to stop operation

- 2-1. Depress the STOP button during play.
- 2-2. The stop lever rises and the arm is raised simultaneously.
- 2-3. The solenoid lever is released from the gear 1 pawl by the force of the arm.
- 2-4. Gear 1 goes through half a rotation and the head base is pulled down.
- 2-5. The tape stops traveling. Refer to Fig. 7.

## 3. Fast forward (FF) and rewind (REW)

- 3-1. Depress the fast forward or rewind button.
- 3-2. Main switch (S2-2) goes ON and the motor rotates.
- 3-3. The pulley with gear positioned in the mechanism center interlocks with the gear of the reel base. (Right reel base with fast forward, left reel base with rewind.) Refer to photos 8 and 9.
- 3-4. The idler part of the pulley with gear is pressed against the flywheel and the rotation is transmitted.
- 3-5. The FF or REW button is locked.
- 3-6. The FF/REW switch (S1-3) and FF SW (S1-2) are for the indicator lighting. Refer to Fig. 9 and Fig. 10.

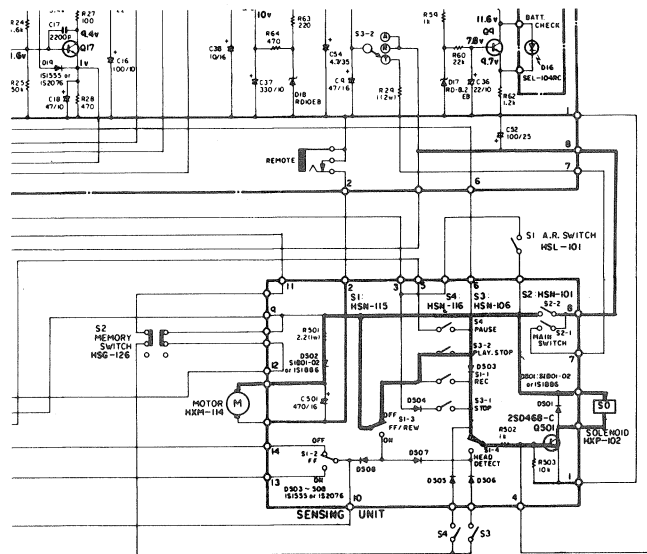
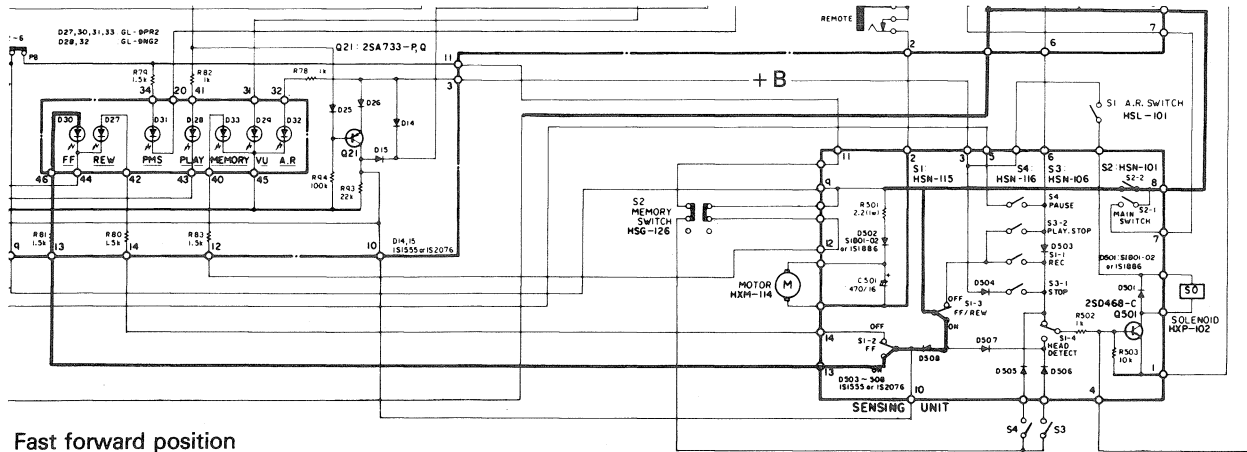


Fig. 8 — PLAY position connection.

## 1. Play operation

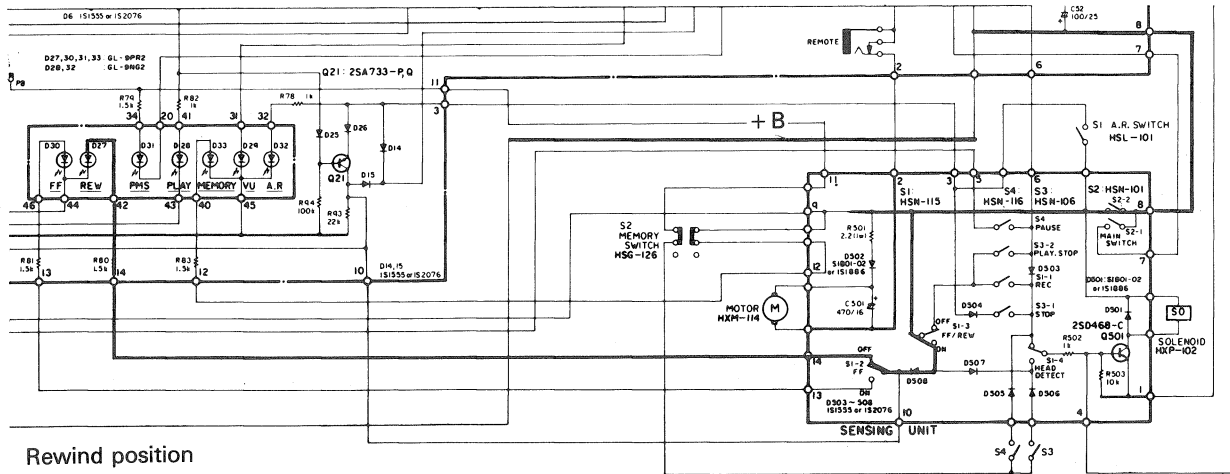
- 1-1. Set the play button to ON.
- 1-2. The main switch (S2-2) goes ON. The motor starts up.
- 1-3. The PLAY/STOP switch (S3-2) goes ON.
- 1-4. Q501 turns ON via the head detect switch (S1-4).
- 1-5. The solenoid goes on and gear 1 starts to rotate.
- 1-6. The head base rises and the tape starts to travel.
- 1-7. The head detect switch (S1-4) goes OFF and Q501 also turns off. Refer to Fig. 8.



Fast forward position

Fig. 9

FF/REW SW (S1-3): ON  
FF SW (S1-2): ON



Rewind position

Fig. 10

FF/REW SW (S1-3): ON  
FF SW (S1-2): OFF

#### 4. Play to FF or REW operation

- 4-1. Depress the FF or REW button during play.
- 4-2. The FF/REW switch (S1-3) goes ON. During play the head detect switch comes into contact with the diode D507 side and so Q501 goes ON. Refer to Fig. 11.
- 4-3. The solenoid is attracted, gear 1 goes through half a rotation and the head base is pulled down.
- 4-4. Subsequent operations are based on section 3) FF/REW operations.
- 4-5. Once the head base moves down, the head detect switch (S1-4) is connected to the diode D503 side.

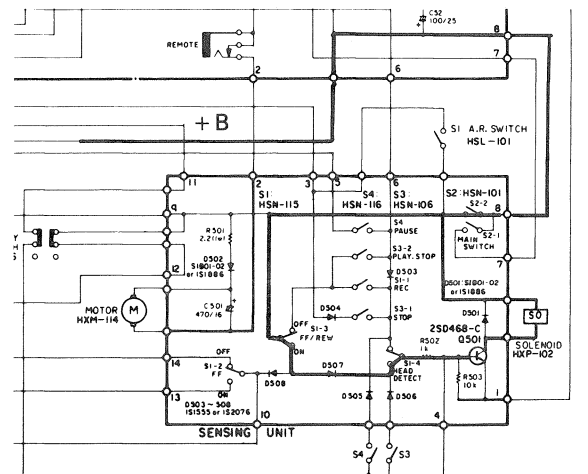


Fig. 11

## 5. Auto repeat (one-side only) operation

- 5-1. Set the auto repeat switch to ON. The main switch (S2-2) goes ON and the motor starts up.
- 5-2. When the auto repeat switch is at ON, the position of the pulley with gear is the same as that in the REW mode.
- 5-3. Upon completion of the REW operation, the tape stops and the auto-stop operation is performed. Refer to the section on the auto-stop operation.
- 5-4. The solenoid pawl is released due to the auto-stop operation and gear 1 goes through half a rotation.
- 5-5. Gear 1 goes through half a rotation, the head base rises and the deck is set to the play mode. The pulley with gear is released from the gear on the leftside reel base due to lever 1's action. Refer to Fig. 13.

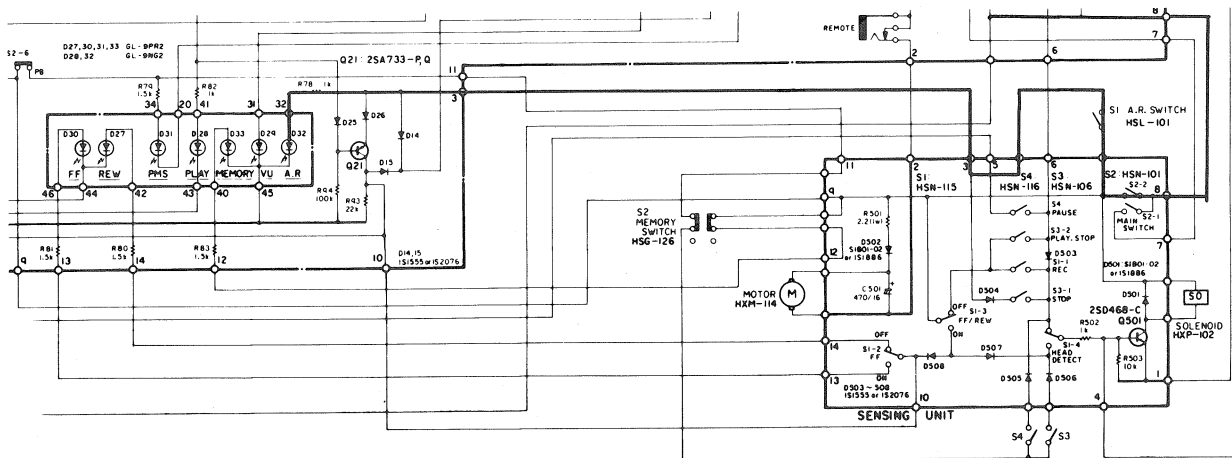


Fig. 13

- 5-6. After the tape has completed traveling in the play mode, the tape stops and the auto-stop operation is performed. Gear 1 goes through half a rotation, the head base moves down and the deck is set to the REW mode.
- 5-7. Operations in 5-3 through 5-6 are repeated. The auto repeat switch (S1) is for setting the indicator to ON.

- 7-2. The unrecorded blanks on the tape are detected in the FF or REW mode. A positive pulse is fed out from the PMS circuit.
- 7-3. The pulse enters the base of sensing unit Q501 and Q501 turns ON. The solenoid is activated and gear 1 goes through half a rotation.
- 7-4. The head base is raised and the tape is set to the traveling state. Refer to Fig. 15.
- 7-5. Once the FF or REW button is depressed, gear 1 goes through half a rotation again and a return is made to the operations in section 7-2.

## 6. One-touch recording operation

- 6-1. Depress the REC button. The main switch (S2-2) goes to ON and the motor starts up.
- 6-2. The REC switch (S1-1) goes to ON and the solenoid is attracted. Gear 1 goes through half a rotation and the tape is set to the traveling mode. Refer to Fig. 14.

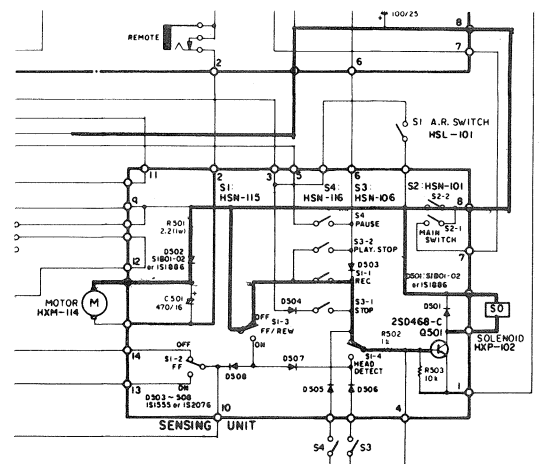


Fig. 14

## 7. PMS (Song Finder) program search operation

- 7-1. Set the PMS switch (S5-4) to ON. The solenoid circuit of the sensing unit and the circuit (PMS or Song Finder™ circuit) for detecting the unrecorded

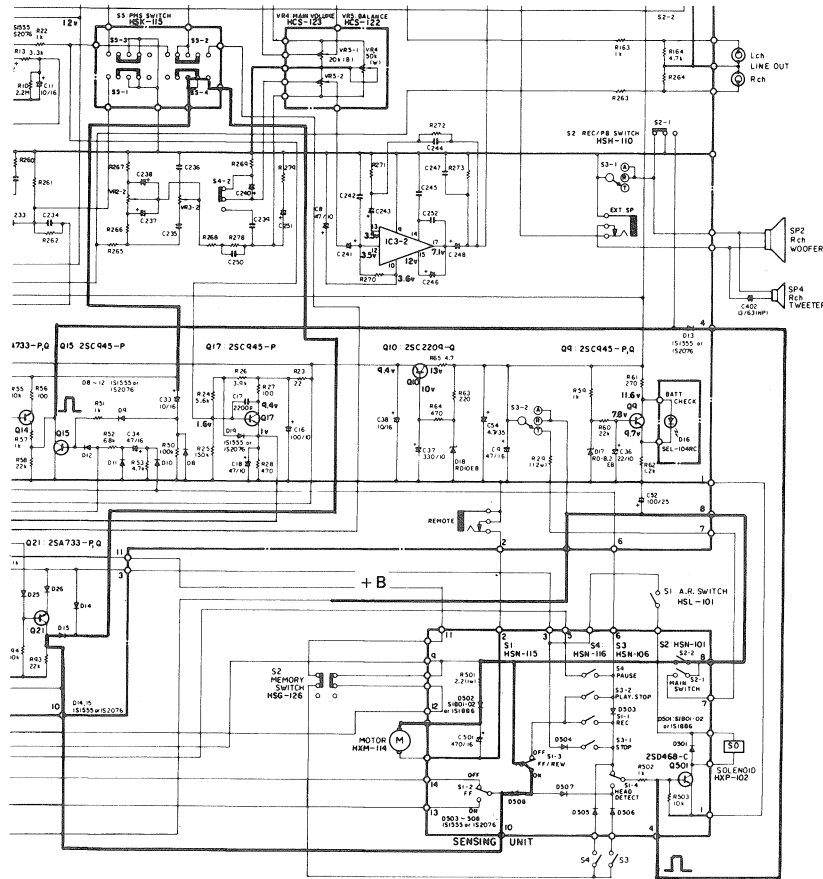


Fig. 15

### 8. Programmable repeat operation

- 8-1. Set the auto repeat switch to ON and the memory switch also to ON.
- 8-2. Set the start button (counter SW S-4) and end button (counter SW S-3) to the beginning and end of the portion of tape to be heard.
- 8-3. The tape arrives at the portion to be heard from the play mode (main switch S2-2 at ON; head detect switch S1-4 at counter switch S-3 side). Counter switch S-3 goes ON.

- 8-4. The solenoid goes ON, gear 1 goes through half a rotation and the head base moves down. The auto repeat button is at ON and so the deck is set to the REW mode.
- 8-5. When the tape comes to the start of the portion to be heard, the counter switch S-4 goes ON.
- 8-6. The solenoid goes ON again, gear 1 goes through half a rotation and the head base is raised. The deck is then set to the play mode again.
- 8-7. The operations are then repeated from 8-3.

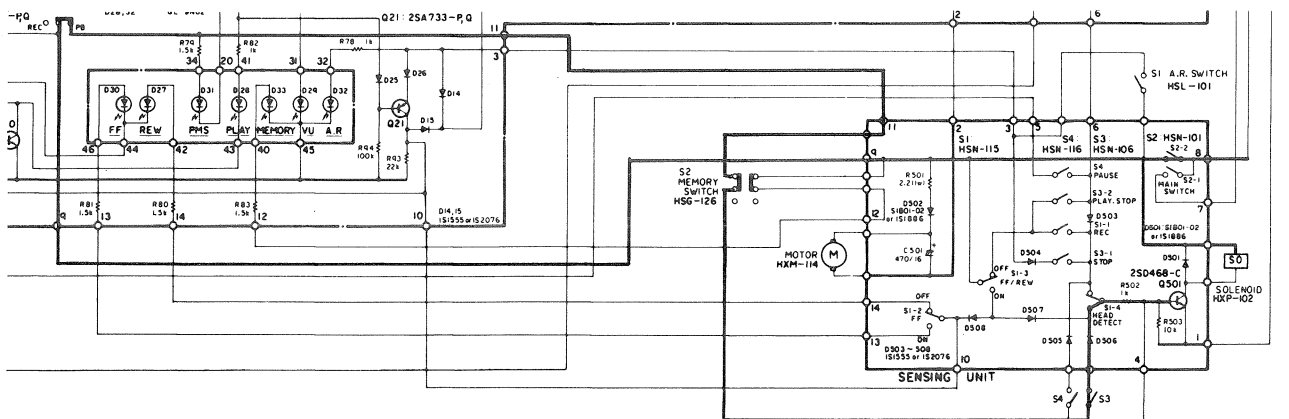
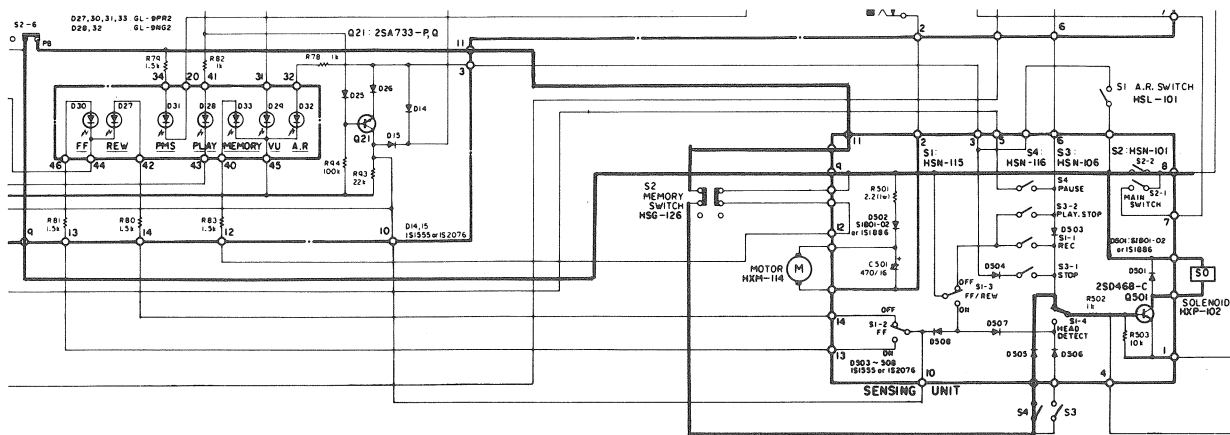


Fig. 16(a) Solenoid operation at end of tape portion





16 (b) Solenoid operation at beginning of tape portion

### 9. One-song repeat operation

9-1. The auto repeat switch is at ON and the PMS (Song Finder) switch is at ON.

Refer to section 8) programmable repeat operation for this operation.

The pulse signal from the PMS (Song Finder™) circuit performs the counter switch S-3 and S-4 operations. Pulses are generated at the tape portion's start and end unrecorded blanks, and the same operations as those in section 8 are performed.

The 7-song skipping function which is featured only in model SK-95 combines a microprocessor with the PMS circuit. The prime feature is at what number

unrecorded blank the pulse is generated. We shall not proceed to describe this in detail although the general idea of the operation has no doubt been understood.

### 3. PMS Circuit

We shall now describe the PMS (Song Finder™) circuit in detail, starting with the configuration of the circuit and then proceeding to discuss the individual circuits.

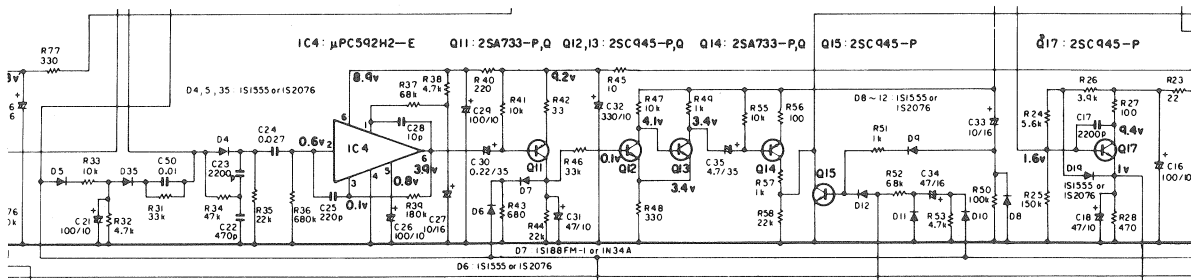


Fig. 17 PMS circuit

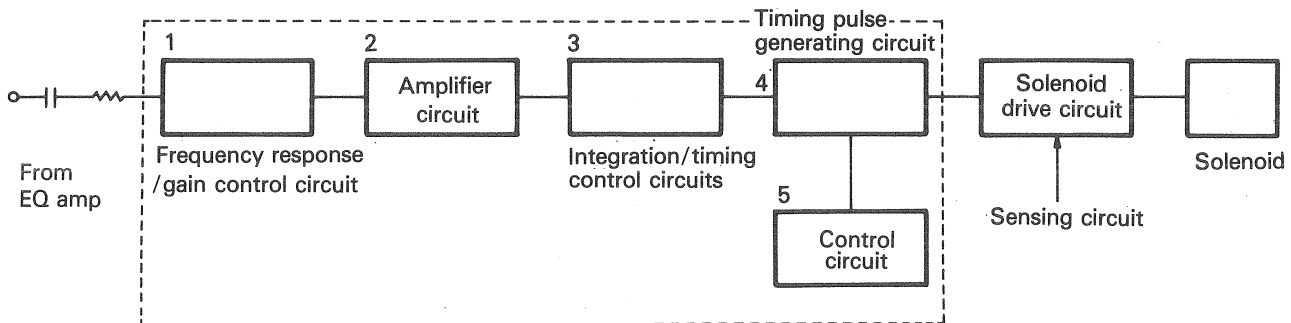


Fig. 18

The signal for the PMS circuit is made by detecting the unrecorded blank (more than 4 sec. provided by the editor mechanism) between the programs with the playback head. Because the detection head also serves as the playback head and the detection output differs with FF (REW) and PLAY positions due to their transportation speed difference, the circuit in Fig. 18 is adopted in the unit.

### 3-1. Frequency response compensation and gain control circuit

During FF (REW), the tape speed is much faster than PLAY, so the output signal level is comparably high and has many high-frequency components. Therefore, this circuit employs a band-pass filter (BPF) in order to adjust the signal level and frequency characteristics to those of PLAY and cut off the undesirable frequency for PMS signal detection.

As in the figure 19, +B (supply voltage for PLAY) is applied during the play mode when the PLAY switch. This potential switches D<sub>5</sub>, D<sub>35</sub> and D<sub>4</sub> to ON and the signal from the EQ amplifier enters the amplifier circuit through D<sub>4</sub> and not the BPF made up of R<sub>34</sub>, C<sub>23</sub>, C<sub>22</sub> and R<sub>35</sub>. But during FF (or REW) +B is not supplied to the circuit and so D<sub>4</sub> is turned OFF. Thus the signal passes through the BPF via R<sub>34</sub>. This filter compensates for the frequency characteristic of the signal, the amplitude of signal is divided (attenuation of about -10 dB) by R<sub>34</sub> and R<sub>35</sub> and virtually the same signal level is fed to the amplifier circuit as that during the play mode.

R<sub>33</sub>, R<sub>32</sub> and C<sub>21</sub> configure a delay circuit which makes the +B potential rise slowly to prevent pulse-like noise from being generated. C<sub>50</sub> and R<sub>31</sub> are a trap circuit designed to prevent the signal from entering the +B side and impairing the +B potential stability.

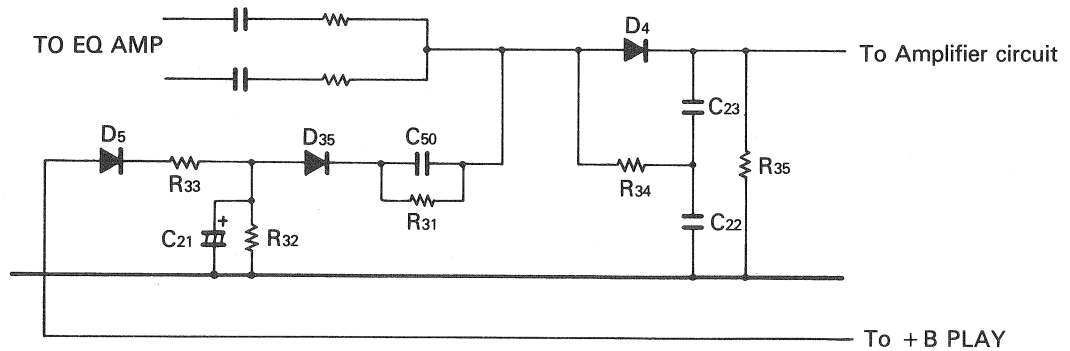


Fig. 19

### 3-2. Amplifier circuit

This circuit is an ordinary linear amplifier. The output signal appearing at IC pin 6 is not used as the audio signal but as the control signal and so when viewed with an oscilloscope, a waveform is seen such as that in Fig. 20.

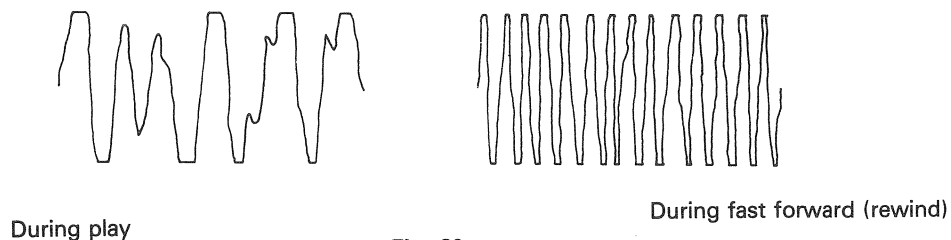


Fig. 20

### 3-3. Integration and timing control circuits

This circuit requires DC for the control signal, while the output signal from the linear amplifier is AC. So it is necessary to convert the output signal property to DC. Therefore the integration circuit is adopted to convert the output signal to DC.

Also the solenoid operation timing is set by using the discharge time of the integration circuit.

Since the tape is running at high speed during FF (REW), the next program is picked up by the inertia of the rotation unless the solenoid is activated at the same time as the detection of the unrecorded blank for PMS. During play, when the solenoid is activated quickly, it takes some time until the next program is picked up (because of the 4-second unrecorded blank). The timing control circuit therefore functions to fix music start the timing during the play and FF (REW) modes.

In the circuit shown in Fig. 21, the output of the amplifier circuit enters the base of Q<sub>11</sub> via C<sub>30</sub>. Q<sub>11</sub> is a PNP type transistor and so when the signal is made a negative region, it turns ON by the B-E bias applied. The action is reversed when the signal is positive so that, in accordance with the signal change, Q<sub>11</sub> turns ON and OFF reciprocally. When Q<sub>11</sub> turns ON, C<sub>31</sub> is rapidly charged via R<sub>42</sub> and the collector of Q<sub>11</sub>. When it turns OFF, C<sub>31</sub> discharges but this takes some time since the charge goes through R<sub>43</sub> or R<sub>44</sub> depends on +B. As a result, a DC voltage is fed out from the collector of Q<sub>11</sub> while the signal enters to Q<sub>11</sub> base. Hence the signal is integrated actually.

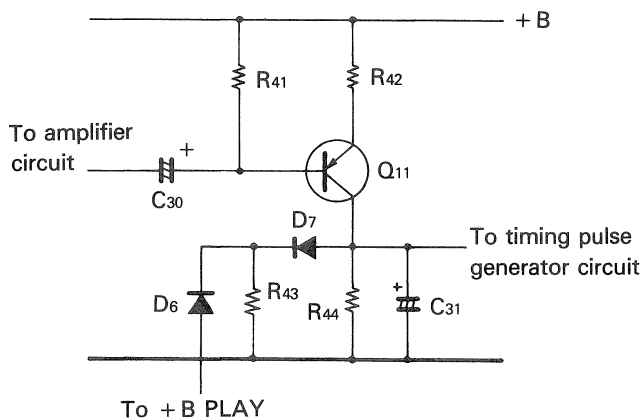


Fig. 21

Now we will explain the difference between what happens in the play and FF (REW) modes. When the song is completed in the FF (REW) mode, or when in other words the no-signal portion of the tape is reached, Q<sub>11</sub> turns OFF and C<sub>31</sub> starts discharging. This discharge current flows through D<sub>7</sub> and low resistance R<sub>43</sub> so that it discharges rapidly.

However, during play, +B (PLAY) goes through D<sub>6</sub> and a reverse bias is applied to D<sub>7</sub> so that D<sub>7</sub> turns OFF. This means that C<sub>31</sub> discharges through R<sub>44</sub> only. This characteristic is shown in Fig. 22.

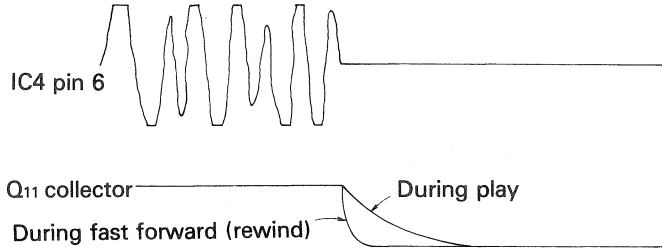


Fig. 22

### 3-4. Timing pulse generating circuit

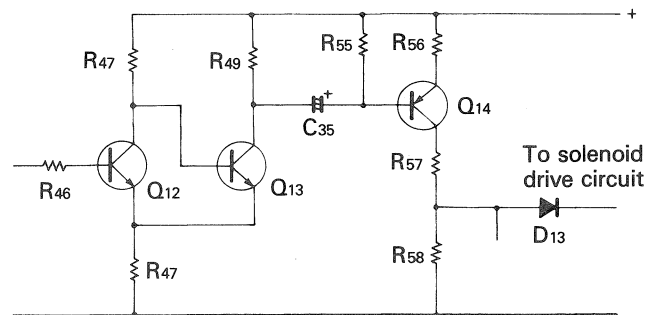


Fig. 23

This circuit serves to generate the pulse for activating the solenoid using the above-mentioned C<sub>31</sub> discharge characteristic curve. While music or a song is being played, bias is applied to the base of Q<sub>12</sub> and so Q<sub>12</sub> turns ON and Q<sub>13</sub> OFF. (Q<sub>12</sub> and Q<sub>13</sub> configure a Schmitt circuit.) This is why no bias is applied to Q<sub>14</sub> and so, in other words, it turns OFF, or the potential at the collector of Q<sub>14</sub> is zero.

When a no-signal portion of the tape is reached, the base potential of Q<sub>12</sub> drops due to the C<sub>31</sub> discharge and when it has fallen below a certain level, Q<sub>12</sub> turns OFF and Q<sub>13</sub> turns ON. Once Q<sub>13</sub> turns ON, the collector potential of Q<sub>13</sub> falls and so a charging current runs to C<sub>35</sub> through R<sub>55</sub>. So when the base potential of Q<sub>14</sub> drops, Q<sub>14</sub> turns ON, potential appears at the collector, this is applied to the solenoid drive circuit and the solenoid is activated. When C<sub>35</sub> has completed charging, Q<sub>14</sub> turns OFF. As a result, a pulse is generated and its width is decided by the C<sub>35</sub>'s charging time.

Fig. 24 shows the overall waveform.

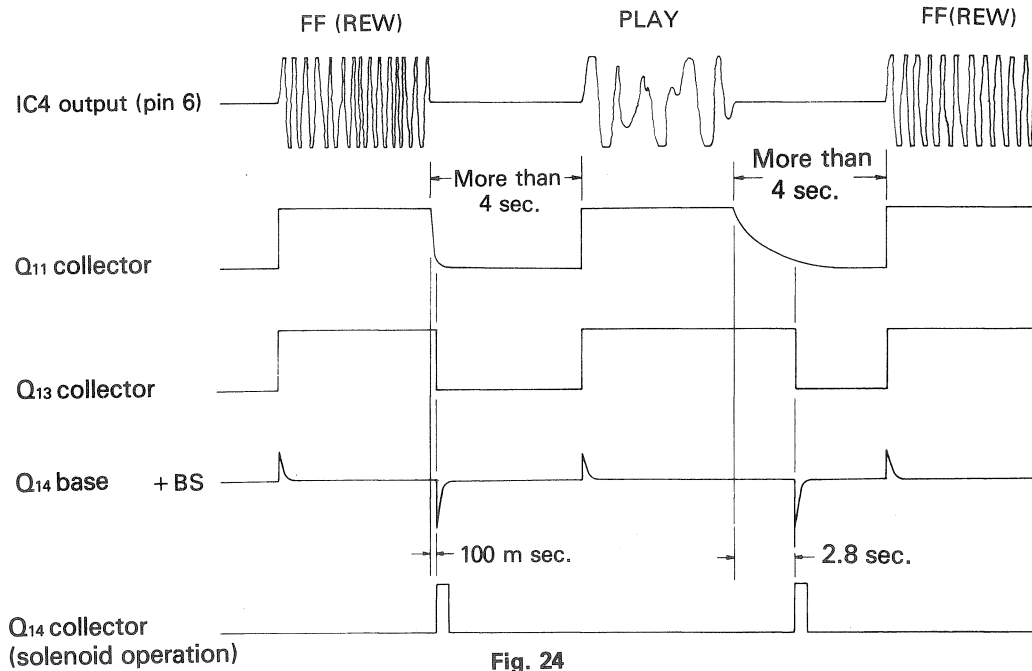


Fig. 24

### 3-5. Pulse control circuit

This circuit serves to control the operation of the solenoid. It plays three roles:

1. It inhibits the operation of the solenoid when the PMS switch is ON or when + BS is ON.
2. It inhibits operation during pause.
3. It stabilizes operation at the start of play during PMS and one-song repeat operations.

#### 3-5-1. Inhibition of solenoid operation with PMS switch ON and + BS ON. (Refer to Fig. 23)

When + BS is supplied, bias is applied to Q<sub>13</sub> and Q<sub>13</sub> turns ON, a charging current runs to C<sub>35</sub> and so Q<sub>14</sub> turns ON. In this state, the solenoid operates. Therefore, this operation is inhibited by C<sub>33</sub>, R<sub>50</sub>, D<sub>9</sub>, R<sub>51</sub> and Q<sub>15</sub>, etc.

When + BS is supplied, a charging current flows to C<sub>33</sub>. Since bias is applied to the base of Q<sub>15</sub> through D<sub>9</sub> and R<sub>51</sub>, Q<sub>15</sub> turns ON. Once Q<sub>15</sub> turns ON, the collector of Q<sub>15</sub> is grounded and so Q<sub>14</sub> turns ON and the solenoid is not activated because of grounding even if a pulse is generated.

#### 3-5-2. Inhibition of operation during pause

Bias is applied to Q<sub>15</sub> from the pause switch via R<sub>54</sub> and D<sub>12</sub> so that Q<sub>15</sub> turns ON and the solenoid does not operate.

#### 3-5-3. Stabilization of operation during play start with PMS, one-song repeat operation

During PMS and one-song repeat operations the deck is automatically set from the FF (REW) mode to the play mode. The main switch is still set on at this time. The

deck performs the play mode with + BS supplied but this circuit is provided to stabilize the operation during play start. By supplying + B (PLAY), a charging current flows to C<sub>34</sub> via D<sub>10</sub> and bias is applied to Q<sub>15</sub> via R<sub>52</sub> and D<sub>12</sub>. Therefore, the C<sub>34</sub> charging time confirms the stabilization of operation during play start.

The above explanation has now made it clear how the pulse is generated from the PMS (Song Finder<sup>FM</sup>) circuit.

It is a good idea to come into close contact with the mechanisms and study them in order to more readily understand the operations of the multi-play deck and PMS circuit.

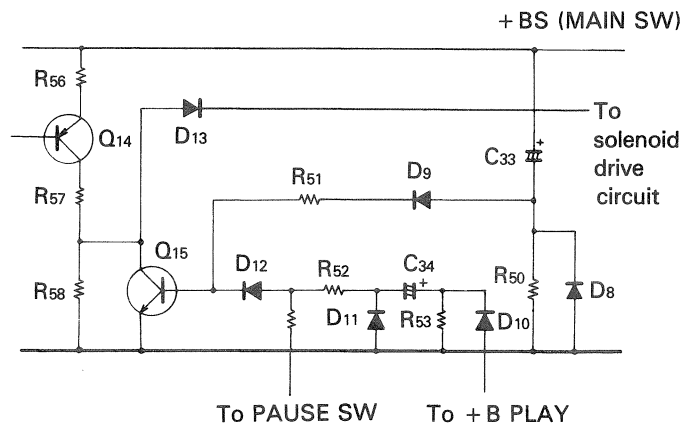


Fig. 25

# First Step in Audio

## Specifications

### TAPE DECKS

In this issue we shall take a look at the specifications of tape decks.

Hi-Fi tape decks can be mainly classified into cassette and open-reel decks although the mainstream of the two in terms of sales and types is the cassette deck. The discussion will therefore center on the cassette decks. The major specifications given on the leaflets and instruction manuals of these decks are wow/flutter, frequency response and signal-to-noise ratio.

If the specifications are viewed closely, notes will be seen which was not the case with amplifiers (in charge of audio frequency), tuner (radio frequency) and turntables (rotating mechanism) in Tuning Fork issued so far.

These notes are provided because the tape deck is not a

single-passive-function piece of equipment designed to reproduce or receive signals, but a positive recording playback piece of equipment using a magnetic tape as the recording medium. Since tape decks use magnetic tapes, the specifications differ by the difference in the electromagnetic transduce characteristics of the tape and deck. This means that notes on measuring conditions must be provided.

The measuring conditions are mostly based on DIN standards because of their popularity in the field of tapes and tape decks.

Reference test tapes are required to measure the specifications of a tape deck. We will begin with the important test tape.

### Specification of tape deck

Type	Compact cassette tape deck, 2-channel stereo/mono	Other Features	(1) Dolby system (ON/OFF) with LED indicator (2) Tape selector (METAL/CR/Fe-Cr/STD) with LED indicator (3) FLUROSCAN display Peak level meter (-20dB to +8dB) (4) Automatic rewind (stop/play) (5) Memory stop and play (6) REC Mute with LED indicator (7) Timer aid recording/playback device (8) Output level control (clicked for reference level, Left/Right coupled) (9) Cassette compartment illumination
Motors	High torque DC Servo motor for capstan drive, DC torque motor for fast forward and rewind	Power Requirement	120V 60Hz only
Heads	"Sendust Alloy Solid" recording/playback head x 1 Ferrite erasing head x 1	Power Consumption	28 watts (UL)
Fast Winding Time	Within 90 seconds (C-60 tape)	Dimensions	Without package 16-9/16(W) x 4-3/4(H) x 11-7/16(D) inches 420(W) x 120(H) x 290(D) mm
Wow and Flutter	No more than 0.04% (WRMS)	Weight	Without package 18 lb 5 oz /8 3kg
Frequency Response		<b>NOTES:</b>	
Standard, LH tapes (-20dB)	20 to 17,000Hz (25 to 15,000Hz ±3dB)	(1) Reference tape Standard, LH tape are DIN 45513 Chrome tape is DIN 45513 (Cr)	
Ferrichrome tape (-20dB)	20 to 18,000Hz (25 to 17,000Hz ±3dB)	(2) Reference recording level is meter 0dB level (160 nwb/m magnetic level = Philip's cassette reference level)	
Chrome tape (-20dB)	20 to 18,000Hz (25 to 17,000Hz ±3dB)	(3) Reference signal is 333Hz	
Metal tape (-20dB)	20 to 8,000Hz	(4) Wow and Flutter ±1.3kHz, WRMS (JIS) at 3.150Hz weighted PEAK (DIN 45507)	
	20 to 19,000Hz (25 to 18,000Hz ±3dB)	(5) Frequency Responses are measured at -20dB and at 0dB levels respectively for reference recording level. Dolby off Level deviation is ±6dB (where not indicated) (DIN 45500)	
	20 to 13,000Hz	(6) S/N is measured at +4dB level for reference recording level (250 nwb/m magnetic level = reference level of DIN 45513) with IEC A curve when weighted (DIN 45500)	
Signal-to-Noise Ratio	Dolby Off more than 59dB Dolby On more than 69dB (over 5kHz, standard, LH tapes) When a chromium dioxide tape is used S/N is further improved by 4.5dB over 5kHz	(7) Sensitivity Input level (mV) for reference recording level measured with input (recording) level control set at maximum position	
Harmonic Distortion	No more than 1.2% (0dB)	(8) Maximum allowable input level (mV) is measured at the point where the output signal wave is clipped while gradually turning the input level control	
Inputs (Sensitivity/Maximum allowable inputs/impedance)	MIC x 2, 0.3mV/30mV/5k ohms, 6mmØ jacks (Reference MIC impedance: 250 ohms to 5k ohms) LINE x 2, 50mV/10V/80k ohms, pin jacks	(9) Reference output level is fluorescent display 0dB level	
Outputs (Reference level/Maximum Level/Load impedance)	LINE x 2, 300mV/400mV/50k ohms, pin jacks HEADPHONES x 1, 90mV/125mV/8 ohms, 6mmØ stereo jack with output level controls	(10) Maximum output (Playback) level: Output level to reference recording level, measured with an output (Playback) level control set at maximum position	
Semiconductors	Amplifier Section ICs, 8 Transistors, 56 Diodes, 67 including 5 zener diodes and 6 LEDs Motor Control Section IC, 1 Diode, 1	<b>*Specifications quoted for "metal" tapes are approximate. See manufacturers' data for individual tapes.</b>	

## 1. Test Tape

A test tape is a reference to measure performance, to adjust the characteristics of a tape deck and to obtain compatibility between tapes and decks. It is designed to be used without posing any problems with a tape deck of any make.

any make.

(Almost all test tapes are based on the specifications given in DIN 45513 Blatt 6 and Blatt 7)

Pioneer test tapes are also based on DIN standards.

Kind	Model	Purpose	Tape speed/ Type	Construction
Reel-to-Reel	STD-101	Tape speed Wow & flutter	19 cm/sec.	
	STD-145		38 cm/sec.	
	STD-151	Overall adjustment of playback system	19 cm/sec.	
	STD-154		19 cm/sec.	
	STD-501	Overall adjustment of record and playback system	Normal tape	
	STD-502		L H tape	
Cassette	STD-301	Tape speed wow & flutter	4.75 cm/sec.	
	STD-331	Overall adjustment of playback system	Time const. 1590 + 120 μm sec.	
	STD-331A		Time const. 3180 + 120 μm sec.	
	STD-341		Time const. 1590 + 120 μm sec.	
	STD-341A		Time const. 3180 + 120 μm sec.	
	STD-601	Overall adjustment of record and playback system	Normal tape	
	STD-602		Chrome tape	
	STD-603		High position tape	
STD-604	Metal tape			

Table 1 Listing of test tapes made by Pioneer

### 1-1. Required conditions of test tape

So that it may be a reference for adjustment and measurement, the tolerance of the recording level, frequency, azimuth, etc. from the standards must be absolutely minimal.

This is why the materials of the tape are selected carefully and only those with the best characteristics are used. At the raw tape stage, the magnetic surface of the tape is first lapped to obtain smooth contact with the tape-transport system including the magnetic heads.

Then a certain frequency signal is recorded and test tapes are selected among the recorded tapes by rejecting those which have dropouts and uneven sensitivity. Cassette shells are also selected since their dimensional error leads to head azimuth error and decreases high frequency response when ordinary tapes are played on decks which have been adjusted with the test tapes of poor precision.

The characteristics of test tapes are guaranteed only for the labeled side so care should be taken in their use.

## 1-2. Test-tape application and checkpoints

### HOW TO USE

1. Set the tape speed selector to the required tape speed. Before loading the test tape, play a section of another tape to check that the tape edge is not damaged or the tape is not stretched by excessive tension. (Be more careful when selecting tape speeds with reel-to-reel decks.)
2. Using the head demagnetizer, fully demagnetize the heads and the parts in the tape path which become magnetized easily, i.e. the capstan and tape guides.
3. Using the specified head cleaning kit, carefully clean the heads, capstan, tape guides and the pinch roller.
4. Check the tape running condition, head height (core position) and contact between head and tape while playing the leader section of the test tape.

### NOTES

1. After completion of adjustment, do not fast forward the test tape, but wind it in the play mode. Fix the end of the wound tape to the reel flange with a tab (reel-to-reel decks).
2. When storing the test tape, avoid high temperatures, high humidity, direct sunlight and strong magnetic fields (close to an amplifier, tape deck or measuring instrument).
3. Before using the record/playback standard tape (blank tape), demagnetize it with a tape demagnetizer.
4. Test tapes, even unused ones, are subjected to attenuation, especially at high frequencies after long storage. Tapes which were released a year or more ago should be calibrated against a new test tape.

## 2. Wow and flutter (W/F)

The definition of wow/flutter and other standards were given in the chapter "turntables of the last issue", and so they have not been included in this section.

Pioneer takes JIS (Japan Industrial Standards) and DIN standards for measuring the wow/flutter of tape decks. The difference between the two is that JIS method uses

rms (root-mean-square) value while DIN method uses peak-to-peak value for measuring units.

Since the values of the two methods differ, details of the measuring method must be given when the specifications are listed.

The weighting filter used for both measurement methods is exactly the same as that given in the last issue.

### 2-1. JIS measurement method

As in Fig. 1, the measuring instruments are connected to the tape deck under test (TDUT).

The JIS method is called a playback method. The measurement is done by playing a W/F test tape (STD-301, recorded reference signal 3 kHz/-10 dB) on the TDUT through a weighting filter. The rms values of the W/F measured with a W/F meter is expressed in percent.

This measurement is performed at three locations on the tape, at the beginning, center and end, and the measurement period at each location is 10 seconds or more.

The maximum value of the three is taken.

The value is expressed by wrms (weighted rms) because the W/F level is measured after weighted.

The problem now is the wow/flutter inherent in the test tape itself. Some recently developed models have achieved less than 0.03% (wrms) of W/F employing DD-motor-drive system and fin mechanisms.

However, if the test tape itself has a W/F of 0.03% (WRMS) or more, measurement becomes meaningless. The figure of Pioneer's STD-301 test tapes which have a serial number higher than 06695 is maintained less than 0.015% (WRMS) and so this can be used without any problems. The figure of those of 06695 and below is 0.025% (WRMS).

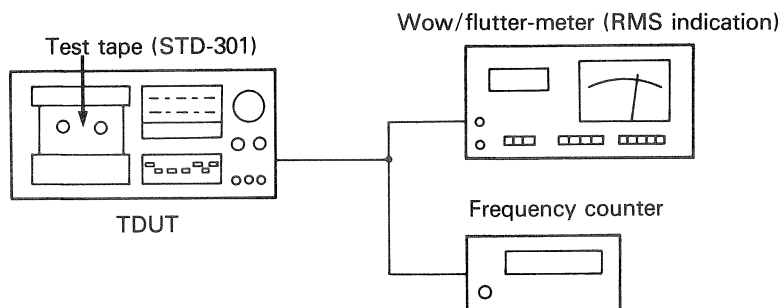


Fig. 1 Setup for measuring wow/flutter by JIS method

## 2-2. DIN measuring method

The DIN method is called a recording and playback method. The reference signal of 3,150 Hz is recorded onto the tape at the level of 0 dB, the recorded tape is then played back, and the output is read out on a wow/flutter meter.

The measuring instruments are connected to the TDUT as in Fig. 2.

First, the reference signal of 3,150 Hz/0 dB (0 VU on the deck's meter) is recorded onto the blank tape (Pioneer's: BASF LHC-60). Then, the recorded portion is played back and the frequency deviation of the reproduced

signal is measured with a W/F meter of DIN45507-quasi-peak indication at the output of the weighting filter which has the characteristics of DIN45507.

The measurement is performed at three locations on the tape, at the beginning, center and end, and the measuring period at each location is 5 seconds. The worst or maximum value of these is taken and expressed in + % (the "+" is added because this is a peak-to-peak value).

Deflections registered in the time taken until the meter has stabilized from starting are excluded.

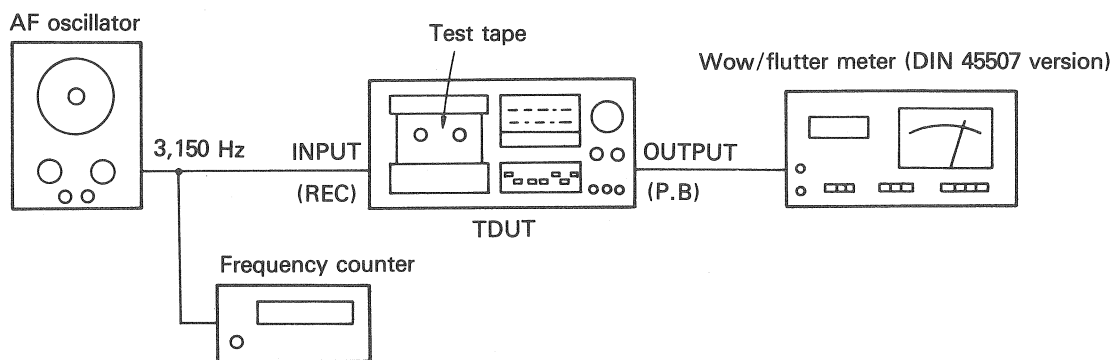


Fig. 2 Setup for measuring wow/flutter by DIN method

## 3. Frequency Response

There are two ways of measuring frequency response: one requires playback frequency response only and the other overall (recording/playback) frequency response.

However, a tape deck is not only for playing a tape but also for recording. Therefore, the specifications given on leaflets, instruction manuals and service manuals are almost always expressed in values obtained from the measurements of the recording/playback method.

The measuring methods of both frequency response and signal-to-noise (S/N) ratio by recording/playback methods are described here. Care must be taken with the test blank tape with this method.

As we explained with the CT-F700 New Products in Tuning Fork No. 3, recording bias current and frequency response are very closely related.

The optimum bias current for tapes is different by tape even when the same material is used, and so, if the bias current of TDUT cannot be changed, the frequency response of the TDUT to various tapes obviously changes.

To safeguard against this, the designated test tape must be used.

Pioneer uses STD-601 test tape for normal position, STD-603 (STD-602) for chrome position and STD-604 tape for metal position.

Spot frequency measurement is used in both of the DIN

and JIS methods. For instance, with the DIN method, measurement is performed at 31.5, 40, 63, 125, 250, 500, 1,000, 2,000, 4,000, 6,300, 8,000, 10,000 and 12,500 Hz with 333 Hz as a reference.

However, with both the DIN and JIS methods, it is impossible to indicate the performance of a deck only with these frequencies since the real objective is more than measuring the performance of a deck: it is to stipulate the minimum requirement to a hi-fi component.

Therefore, a sweep AF oscillator, a spectrometer, a level recorder and other instruments (usually made by B&K) are used to measure from the low frequency range to the high frequency range continuously. (refer to Fig. 5)

Here, we will see a method using an AF oscillator and an AC millivoltmeter. In addition to the above DIN frequencies, measurement is made at random frequencies and the difference from the 333 Hz playback output level is plotted on a graph.

From this graph the range of the frequency within a certain deviation is called the frequency response.

If, for instance, the specification says 25 to 17,500 Hz  $\pm$  3 dB, it means that the comparative response level between 25 and 17,500 Hz to the reference of 333 Hz comes within +3 dB.

If there is no deviation indication, it is impossible to compare frequency response since the deviation allowance



differs by deck manufacturer. The future may possibly see some standardization, however.

Pioneer indicates the frequency response within  $\pm 6$  dB deviation.

Measurement is performed at a recording level which is  $-20$  dB of the reference recording level (0 dB on the level meters of TDUT).

The actual measuring method is outlined below.

The measuring instruments are connected to TDUT and a load resistance (50 kilohms) is connected to the output

terminals as in Fig. 3. The oscillation frequency of the AF oscillator is set to 333 Hz and the deck's input is set for 0 dB recording. Then the AF oscillator output is attenuated by  $-20$  dB and the signals of the frequencies to be measured are recorded.

The recorded tape is then played back, and the output level deviations from the reference level of 333 Hz, are plotted on a graph as in Fig. 4.

The frequency response can then be read on the graph.

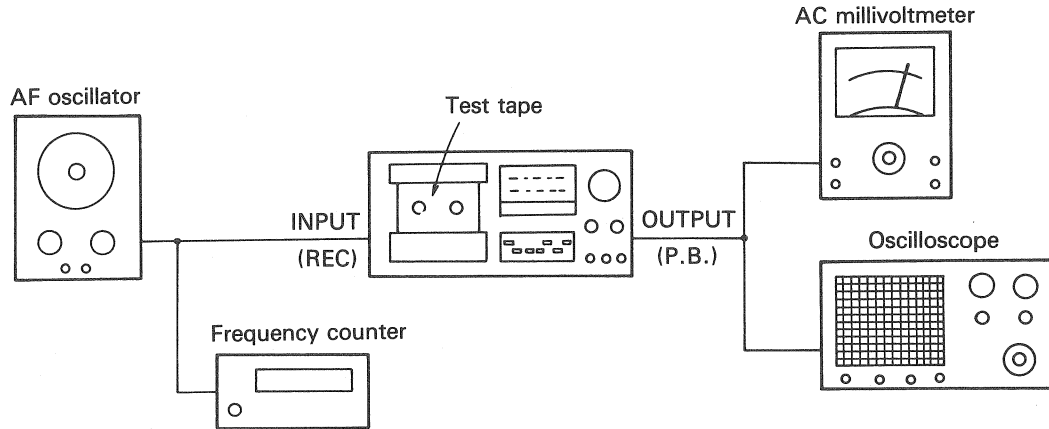


Fig. 3 Connecting diagram for frequency response measurement

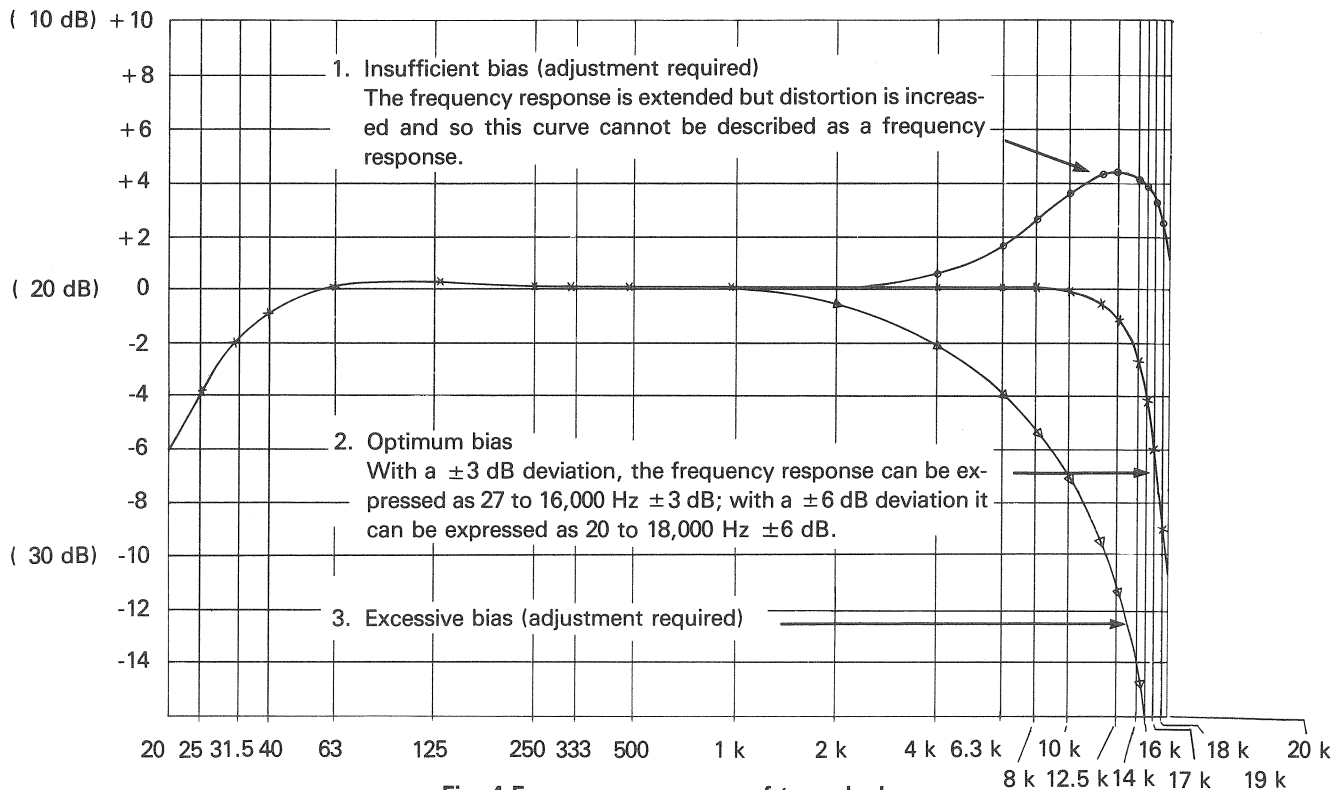


Fig. 4 Frequency response of tape deck

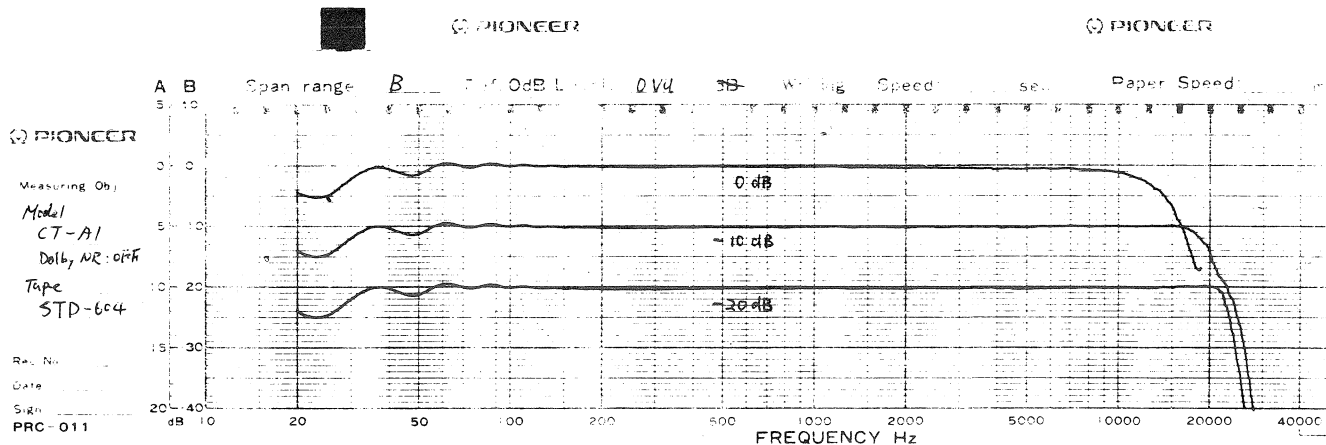


Fig. 5 Frequency response recorder

#### 4. Signal-to-Noise Ratio (S/N)

The recording/playback method is also used to measure the S/N ratio as mentioned in the chapter on the frequency response.

The designated test tape must be used.

By DIN, the recording signal shall be at the level where the tertial harmonic distortion of the 333 Hz signal recorded and played back becomes 3%.

The ratio of the signal level to the weighted noise level is called the S/N ratio.

Sometimes a 250 nWb/m DIN reference level is used as

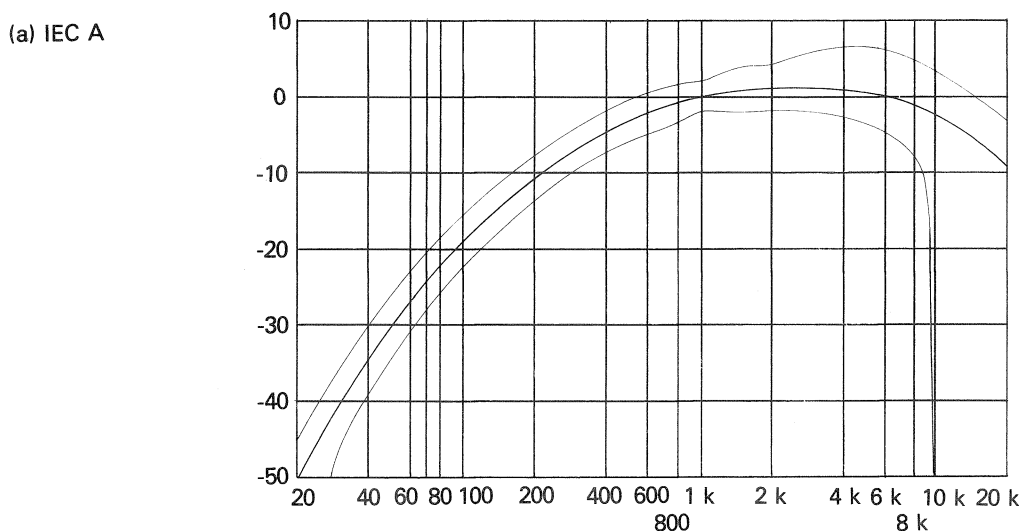
the signal level. In this case, there is a slight difference in the S/N value and so when comparing performance, care must be taken with the signal level. Here, the measuring method which employs the maximum recording level as its signal level is mentioned.

The weighting filter for the S/N measurement is not the same as that used for turntables in the previous issue.

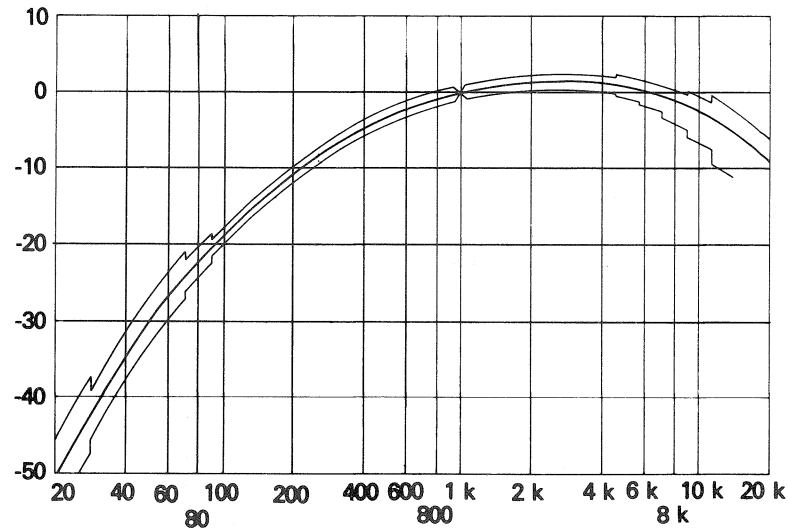
Fig. 5 shows the weighting characteristics usually used for tape decks. Pioneer uses the IEC A curve.

However, as can be seen from the figure, the basic curve can be considered to be almost the same.

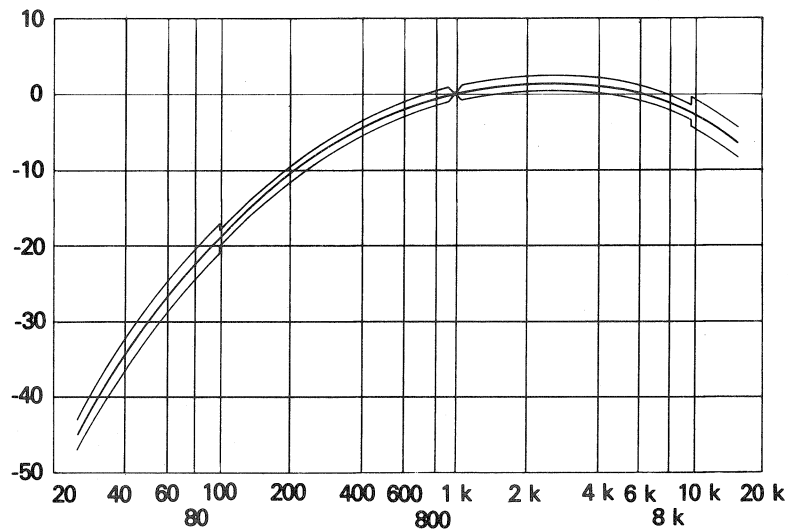
Fig. 6 Weighting characteristics



(b) DIN A



(c) JIS A



The S/N ratio naturally varies when the built-in noise reduction system is switched ON and OFF. This is why ratios are given for both modes.

The measuring instruments are connected to TDUT and a load resistance (50 kilohms) to the OUTPUT terminals as in Fig. 7. The 333 Hz reference frequency signal is recorded and played back, and the INPUT control is adjusted so that the third harmonic distortion is set to 3%. After the tape has been recorded with 3% distortion the

played back level is measured and the tape is rewound partly and the input signal is disconnected (the input terminals are terminated with a dummy resistor which has the same value as the input impedance). Recording is now made without an input signal. The ratio of the level of the 333 Hz reference played back signal to that of the weighted noise, which has been recorded without an input signal, is expressed in dB.

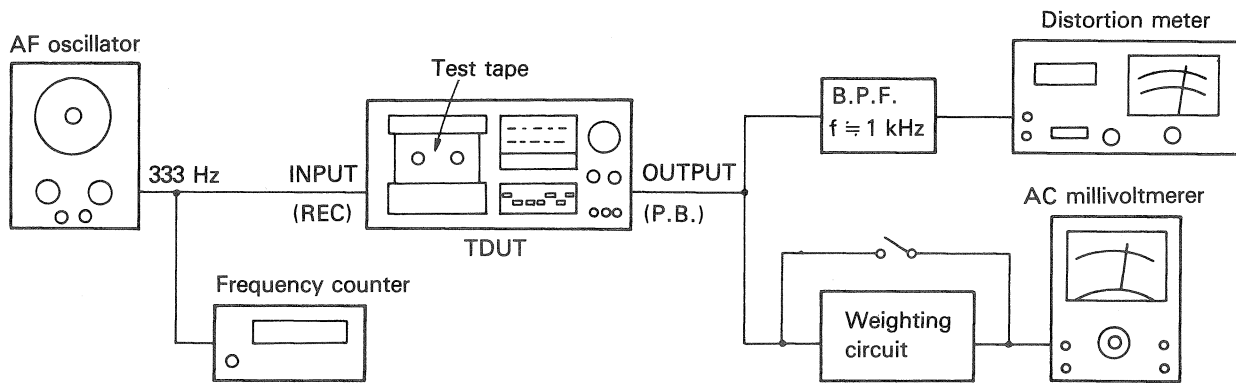


Fig. 7 Connecting diagram for S/N measurement

### Conclusion

The performance of magnetic tapes has a great effect on the measurements of deck specifications. In addition, these magnetic tapes do not have the same characteristics based on uniform standards and so it is impossible to adjust the characteristics of a deck to all the magnetic tapes sold on the market.

Popular tapes with stable performance have been adopted as test tapes.

It is unfortunate that it is impossible to use magnetic tapes and decks at their optimum performance.

A recent trend has been the introduction of many decks provided with a recording bias current control which allows each and every magnetic tape to be used to the full.

The top-class decks have controls which allow not only

the recording bias current but also the recording level and recording equalization to be set optimally.

Another recent trend is the sale of low-cost magnetic tapes. However, if the aim is to enjoy music, the performance of tape decks will not be up to par and so it is better not to use them. Only top-class brands are recommended.

In any comparison of the performance of products made by different companies, it must be understood that there will be differences in the specifications due to differences in the measuring conditions and test tapes.

Although open-reel deck standards have not been mentioned, it is worth remembering that the basic measuring methods are the same despite the different measuring conditions (level, bias).

# Audio Memo

## TIM Distortion/Slew Rate/Rise Time

Nowadays more and more amplifier specifications are including such words as “TIM distortion”, “slew rate” and “rise time”. We believe that these terms are not being understood properly and that the theory behind them has not been expounded properly, and so we will look at the causes of TIM distortion and explain all about the slew rate and rise time.

### 1. TIM (Transient Intermodulation) Distortion

In the past, distortion in an amplifier was usually qualified as THD (total harmonic distortion) and IMD (intermodulation distortion). However, tremendous improvements have since been made in amplifier design techniques and in the performance of parts and components so that in some cases the performance values, such as THD, break the measurable limits of audio frequency oscillators and distortion meters. In addition, distortion for example, has reached minimal figures of 0.001% or 0.002% which is beyond our hearing capability.

Total harmonic distortion, which is measured by use of sine waves (level or frequency is constant), is used to evaluate the linearity of an amplifier. With actual sources, such as music, however, the frequency and output power change continuously. Therefore, it is not sufficient to evaluate the performance of an amplifier only by the value of THD.

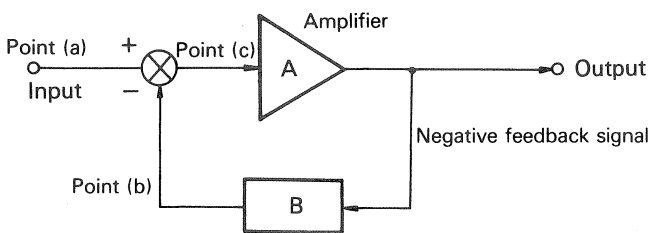


Fig. 1

A method of measuring TIM distortion was brought in to find out the distortion during actual operation (dynamic characteristic). Transient intermodulation distortion is a type of distortion caused by time lag in negative feedback with negative feedback amplifiers, which are most popular currently, and it was first spotlighted in 1970 by Mr. Ojala, a Finn.

Negative feedback amplifiers amplify with minimal distortion by feeding a part of the output signal, which is the inverse of the input, back to the first input stage. However, if the negative feedback signal lags behind the input signal (due to a drop in the amplification at the

amplifier’s high frequency range, phase shifting or the storage effect of transistors), a peak is formed at the mixing stage with the input and feedback signal, and if the peak level exceeds the allowable input (voltage) level the distortion does not decrease but increases as the phase lags.

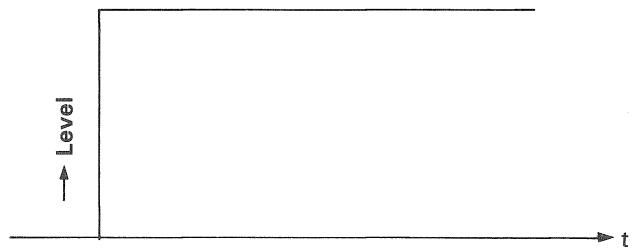


Fig. 2 Input wave form at point (a)

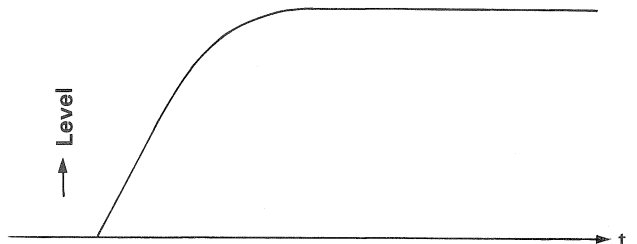


Fig. 3 Output signal waveform (b)  
NFB signal waveform

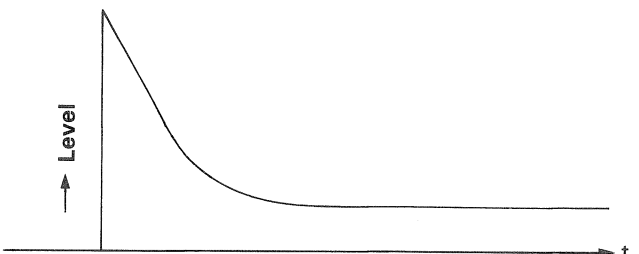


Fig. 4 Waveform at point (c)

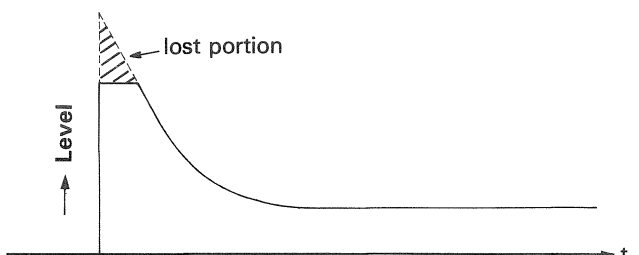


Fig. 5 With clipping at the first stage

**The step of TIM distortion**

- (1) When a sharply rising signal (a), such as a high frequency square wave, is fed to the amplifier A, the output signal waveform will be modulated as in (b) due to the effects of the rise time since there is a limit to the frequency response of the amplifier.
- (2) NFB is a system which feeds a part of the output signal back to the input stage inverting its phase. So waveform (b) turns into waveform (c).
- (3) If the dynamic range of the preamplifier stage is not wide enough the signal will be clipped at its peak and distortion will naturally result. If the transient voltage velocity is limited by the slew rate, the distortion will also result in the same way. (Refer to Fig. 2, 3, 4 and 5)

**Actual signals**

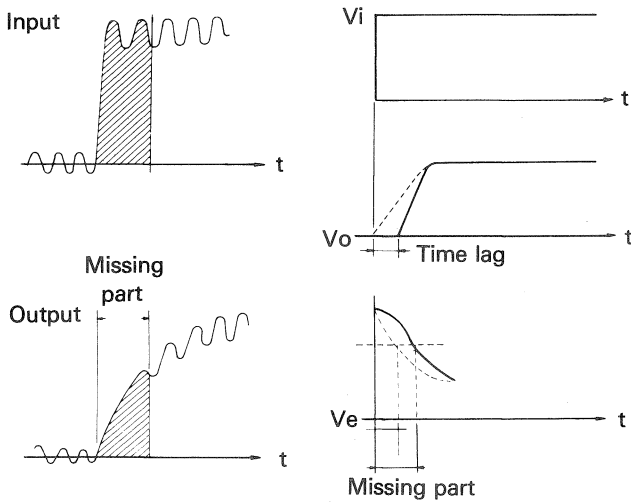


Fig. 6

**2. Rise Time**

If an input signal, such as that represented by the dotted line in the Fig. 7, is supplied to an amplifier, the response characteristics curve will be as per the solid line. The rise time is defined as the time taken for the output signal level to rise up from 10% to 90% of the peak and frequency response of an amplifier is expressed with the maximum frequency at which the amplifier's response gain decreases by 3 dB (about 30%) from the reference level. If the transient curve of the rise time is represented by a natural-logarithmic curve, the following formulae will apply:

$$tr = 0.35/fc \text{ or } fc = 0.35/tr$$

Because of the relationship between the rise time and the frequency response, the rise time becomes short if the frequency response is extended up to the high frequency-range. The rise time is another expression for the frequency response.

**3. Slew Rate**

Slew rate is a kind of frequency response characteristic of an amplifier. It is the rate or velocity limit of change of

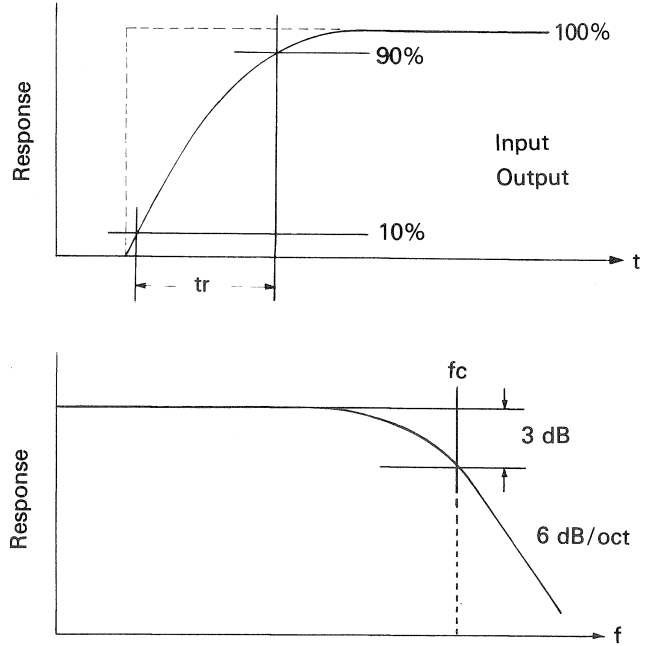


Fig. 7

the output voltage of an amplifier operated within its linear region expressed by the rising output voltage in a limited time ( $\mu\text{sec}$  is normally used as the unit). When the input signal is small, the power bandwidth of an amplifier is almost the same as frequency response, but when the signal amplitude becomes large, the output voltage cannot follow the input transient above a certain speed because of limited current supply.

The testing signal is a square wave, the same as that for measuring rise time. The output level of the amplifier for measuring slew rate is set at the maximum where the reproduced wave is not saturated and has no ripples while the output level for rise time is set at 1 V. The measurement is performed at the portion where the gradient of the rising curve of the reproduced square wave is at the steepest and the value is expressed in  $\text{V}/\mu\text{sec}$ . Therefore, with an amplifier having a slew rate of  $200 \text{ V}/\mu\text{s}$ , up to only 100 volts can be taken out in  $0.5 \mu\text{s}$ , and not up to 200 volts if the amplifier has only 100 volts linear operation region.

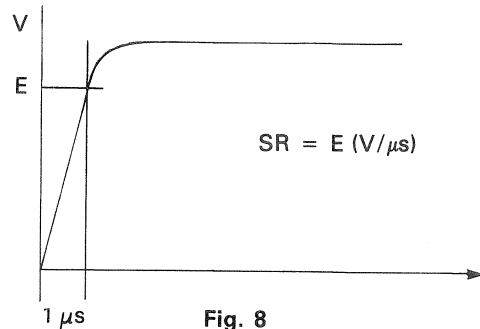


Fig. 8

The slew rate does not change in accordance with the input signal strength. If an input corresponding to 50 V

output is applied to an amplifier with a  $200 \text{ V}/\mu\text{s}$  slew rate, the response curve will trace on the same curve of the slew rate up to  $50 \text{ V}$  point.

Since the rise time is the time taken for the output wave to rise from 10% to 90% of its peak level, the gradient of the waveform is steep with a high input and gentle with a low input. Therefore, when a high input signal is applied to an amplifier which has a gentle slew rate, rise time gradient is sometimes restricted by the slew rate gradient.

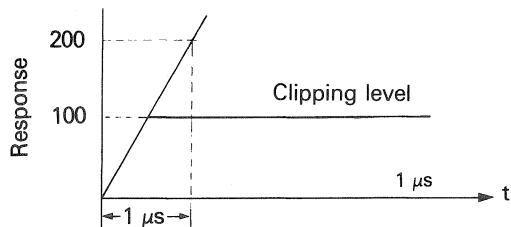


Fig. 9

#### 4. Relationship Between Slew Rate and Rise Time

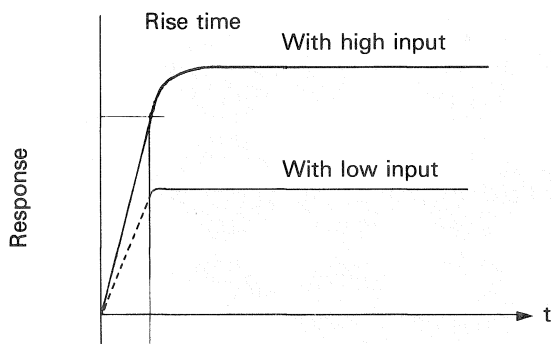


Fig. 10

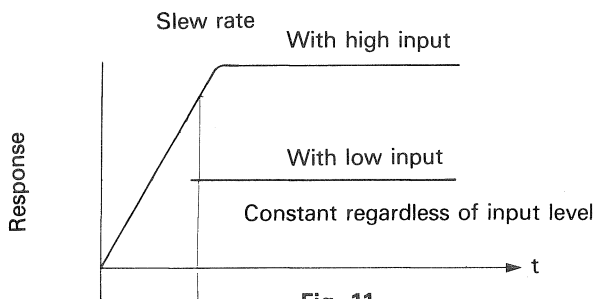


Fig. 11

The rise time is constant, regardless of the strength of the input signal, until it reaches a certain level where it is involved with the slew rate. (The higher the input level, the steeper the rise gradient.)

#### Major causes of TIM distortion

- (1) Insufficient maximum input level in the first stage
- (2) Limitation in rising voltage velocity by slew rate
- (3) Lag in transmission time due to circuit elements (this cause does not appear in frequency response)

- (4) Frequency response of amplifier's closed loop (rise time)

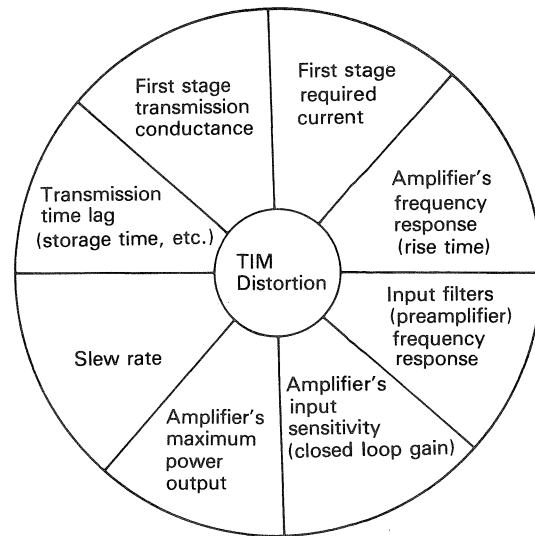


Fig. 12

#### 5. How to Prevent TIM Distortion

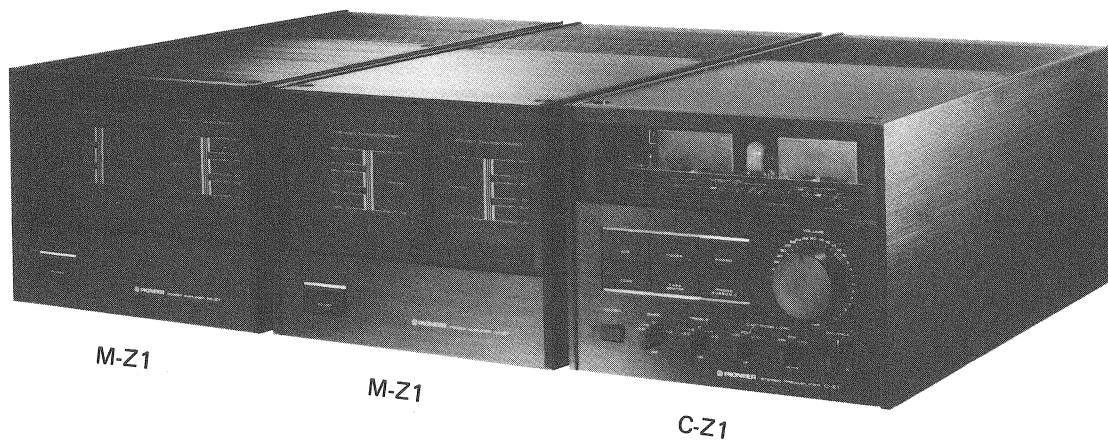
To prevent TIM distortion, it is necessary to make the dynamic range of the first stage wide enough, to eliminate clipping, to make the gradient of slew rate steeper than that of rise time, to let the rise response freely and to make the usable frequency range of power amplifier wider than that of preamplifier. All these points should be taken into consideration when designing. The rising output characteristic of an amplifier against a square wave input is determined by the frequency characteristic and maximum output voltage. If the slew rate is smaller than the maximum gradient, proper output waveforms may be unavailable resulting in TIMD. Therefore, the total performance is not affected by rise time and slew rate as long as the maximum gradient or first stage current is above a certain value, and evaluating an amplifier's performance only with the rise time and slew rate as some manufacturers do is meaningless.

Table 1 has values calculated on the above-mentioned theory. If the slew rate is improved by making the rise time  $1 \text{ } (\mu\text{sec})$ , the power amplifier's frequency response will go up to  $500 \text{ kHz}$  to result in a surplus quality and increased costs. There will also be other adverse effects such as fluctuations in the oscillation level. TIM distortion must be eliminated by attaining a proper balance of all the factors of Fig. 12.

Pioneer has launched on the domestic market non-negative feedback amplifiers (C-Z1 and M-Z1) which, in theory, do not generate any TIM distortion.

Input filter (preamplifier's cutoff frequency) (kHz)	(Power) Amplifier's cutoff frequency (kHz)	Required slew rate ( $V/\mu$ Sec)
100	100	18
	500	34
	1,000	39
500	100	34
	500	93
	1,000	126
1,000	100	39
	500	126
	1,000	185

**Table 1. Required slew rate for a 100 W/8  $\Omega$  power amplifier.**



**Non-NFB Amplifier**



# IN THE NEXT ISSUE

1. New Products ..... PG-coned Speaker HPM-500, HPM-700, HPM-900, HPM-1100
2. New Technique ..... Synthesizer Tuner
3. Parts Information ..... Variable Resistors & Switches
4. Measuring Instrument ..... RC Oscillator
5. First Step in Audio ..... Specifications — Speaker
6. Electricity Basic Theory ..... RL, RC, LC Circuit & Characteristics
7. Understanding More About Antennas ..... Basic Theory on Antenna
8. One-Point Servicing Techniques ..... Tone Burst Test
9. Audio Memo ..... Matching
10. Q & A

---

## Editors' Note:

---

You may be busy in repair-servicing, answering the technical questions of your customers and brushing up your technical ability. After-sales service will really be easy if the circuits and mechanisms of new products are similar to the conventional ones. However, the development in technology does not wait for us. Understanding fundamental principles of electronics and mechanisms is indispensable for us to keep up. We hope to help you understand them and to learn ourselves.

Your frank advice and opinions for making the TUNING FORK informative and useful are very welcome.

Thank you.

---

TUNING FORK No. 5

First printing: 1981

Compiled and edited by

Editors in Chief:

**Ikki Nagashima**

Administration Department

International Division

**Akira Yamashita**

Service Section

Administration Department

International Division

and

Editors:

**T. Taguchi, H. Koike,**

**S. Hirose, Y. Kojima**

**and A. Kogirima**



**PIONEER ELECTRONIC CORPORATION**

4-1, Meguro 1-chome, Meguro-ku, Tokyo 153, Japan

**U.S. PIONEER ELECTRONICS CORPORATION**

85 Oxford Drive, Moonachie, New Jersey 07074, U.S.A.

**PIONEER ELECTRONIC (EUROPE) N.V.**

Luithagen-Haven 9, 2030 Antwerp, Belgium

**PIONEER MARKETING SERVICES PTY. LTD.**

P.O. Box 317, Mordialloc, Victoria 3195, Australia

**PIONEER ELECTRONICS OF AMERICA**

1925 E. Dominguez St., Long Beach, California 90810, U.S.A.

Printed in Japan